



US006813377B1

(12) **United States Patent**
Gopalakrishnan et al.

(10) **Patent No.:** **US 6,813,377 B1**
(45) **Date of Patent:** **Nov. 2, 2004**

(54) **METHODS AND APPARATUSES FOR GENERATING A MODEL OF AN OBJECT FROM AN IMAGE OF THE OBJECT**

(75) Inventors: **Venkat Gopalakrishnan**, Marlboro, MA (US); **Albert Montillo**, Philadelphia, PA (US); **Ivan Bachelder**, Newton, MA (US)

(73) Assignee: **Cognex Corporation**, Natick, MA (US)

(*) Notice: Subject to any disclaimer, the term of this patent is extended or adjusted under 35 U.S.C. 154(b) by 659 days.

(21) Appl. No.: **09/630,004**

(22) Filed: **Jul. 31, 2000**

Related U.S. Application Data

(60) Provisional application No. 60/147,721, filed on Aug. 6, 1999.

(51) **Int. Cl.**⁷ **G06K 9/00**

(52) **U.S. Cl.** **382/146; 382/191; 382/274; 250/559.37**

(58) **Field of Search** 382/146, 145, 382/149, 285, 147, 144, 150, 106, 141, 151, 191, 207, 274; 250/208.1, 235, 559.22, 559.34, 559.36, 559.37, 306; 356/394, 404, 398, 237.5, 418; 348/87, 126

(56) **References Cited**

U.S. PATENT DOCUMENTS

4,843,631 A * 6/1989 Stepinchler et al. 382/280
4,845,764 A * 7/1989 Ueda et al. 382/146
4,912,336 A 3/1990 Nayar et al.

(List continued on next page.)

OTHER PUBLICATIONS

Jae S. Lim, Two-Dimensional Signal and Image Processing, Prentice Hall P T R, Englewood Cliffs, New Jersey, 1990.
The MathWorks, Inc. Radon (Image Processing Toolbox); <http://www.mathworks.com/access/helpdesk/hel/toolbox/images/radon/shtml>.

The MathWorks, Inc., Iradon (Image Processing Toolbox); <http://www.mathworks.com/access/helpdesk/help/toolbox/images/iradon/shtml>.

Cognex Corporation, Cognex 3000/4000/5000 Vision Tool, Revision 7.6, Chapter 4, Caliper Tool, 1996.

Cognex Corporation, Cognex 3000/4000/5000 Vision Tool, Revision 7.6, Chapter 5, Inspection, 1996.

Cognex Corporation, Cognex 4000/5000 SMD Placement Guidance Package, User's Manual Release 3.8.00, Chapter 7, Rectilinear Device Inspection, 1998.

Cognex Corporation, Cognex 4000/5000 SMD Placement Guidance Package, User's Manual Release 3.8.00, Chapter 8, Large-Leaded Device Inspection, 1998.

Cognex Corporation, Cognex 4000/5000 SMD Placement Guidance Package, User's Manual Release 3.8.00, Chapter 15, MFOV-LL Device Inspection, 1998.

Cognex Corporation, Cognex 3000/4400 SMD Tools Release 5.2, SMD 2, 1994.

Timothy S. Newman, Anil K. Jain and H.R. Keshavan, 3D CAD-Based Inspection I: Coarse Verification, pp. 49-52, IEEE, 1992.

Anthony Hoogs and Ruzena Bajcsy, Model-based Learning of Segmentations, pp. 494-499, IEEE, 1996.

Shimon Ullman, Aligning pictorial descriptions: An approach to object recognition, Cognition, vol. 32, No. 3, pp. 193-254, Aug. 1989.

Cognex Corporation, Cognex MVS-8000 Series, GDE User's Guide, Revision 1.1, Apr. 7, 2000.

Primary Examiner—Bhavesh M. Mehta

Assistant Examiner—Sheela Chawan

(74) *Attorney, Agent, or Firm*—Tracy Calabresi

(57) **ABSTRACT**

A method and an apparatus are disclosed for generating a model of an object from an image of the object. First, an orientation of the object in the image is determined through the generation of, and subsequent evaluation of, at least a portion of a frequency response of the image. Thereafter, the orientation is used to gauge the object. The gauging provides the necessary dimensional information that becomes a part of the geometrical model of the object. An embodiment is disclosed that generates a geometrical model of a leaded object from the image of the leaded object.

54 Claims, 15 Drawing Sheets

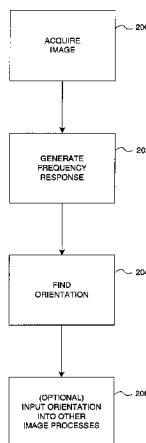

U.S. PATENT DOCUMENTS

4,913,549 A	4/1990	Fujita et al.		5,602,937 A	2/1997	Bedrosian et al.	
4,980,971 A	1/1991	Bartschat et al.		5,621,807 A	4/1997	Eibert et al.	
5,023,916 A	* 6/1991	Breu	382/150	5,625,715 A	4/1997	Trew et al.	
5,060,276 A	10/1991	Morris et al.		5,627,912 A	5/1997	Matsumoto	
5,113,565 A	5/1992	Cipolla et al.		5,627,915 A	5/1997	Rosser et al.	
5,151,822 A	* 9/1992	Hekker et al.	250/550	5,663,799 A	* 9/1997	McAulay et al.	356/398
5,164,994 A	* 11/1992	Bushroe	382/288	5,663,809 A	9/1997	Miyaza et al.	
5,226,095 A	7/1993	Okumura et al.		5,694,482 A	* 12/1997	Maali et al.	348/87
5,268,999 A	12/1993	Yokoyama		5,822,043 A	10/1998	Ebinuma	
5,343,028 A	8/1994	Figarella et al.		5,828,769 A	10/1998	Burns	
5,371,690 A	12/1994	Engel et al.		5,850,469 A	12/1998	Martin et al.	
5,471,541 A	11/1995	Burtnyk et al.		5,974,169 A	10/1999	Bachelder	
5,495,537 A	2/1996	Bedrosian et al.		6,061,587 A	5/2000	Kucharczyk et al.	
5,497,451 A	3/1996	Holmes		6,137,896 A	10/2000	Chang et al.	
5,500,906 A	3/1996	Picard et al.		6,307,951 B1	* 10/2001	Tanigawa et al.	382/103
5,539,518 A	7/1996	Bennett		6,508,767 B2	1/2003	Burns et al.	
5,545,887 A	8/1996	Smith et al.		6,556,704 B1	* 4/2003	Chen	382/154

* cited by examiner

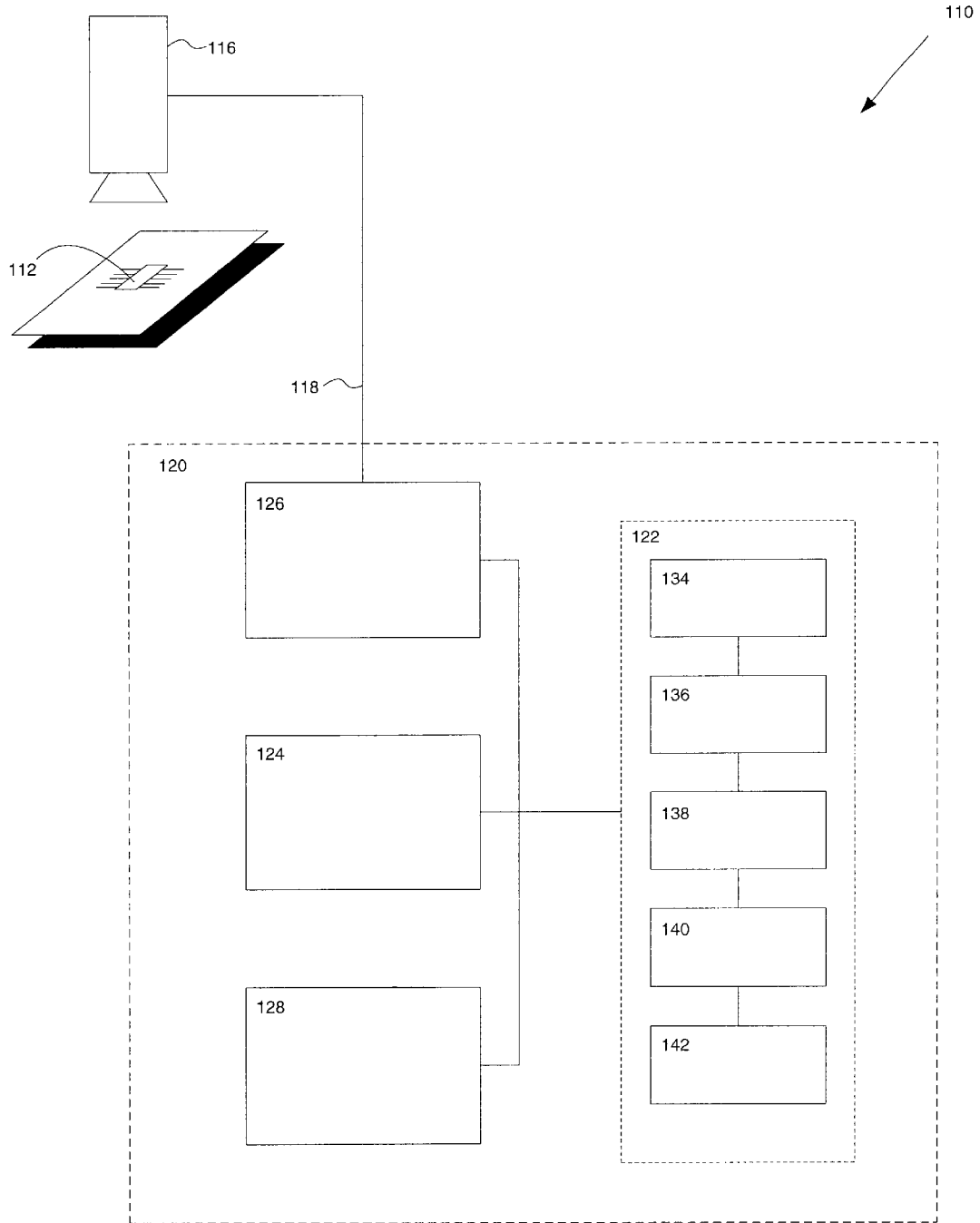

FIGURE 1

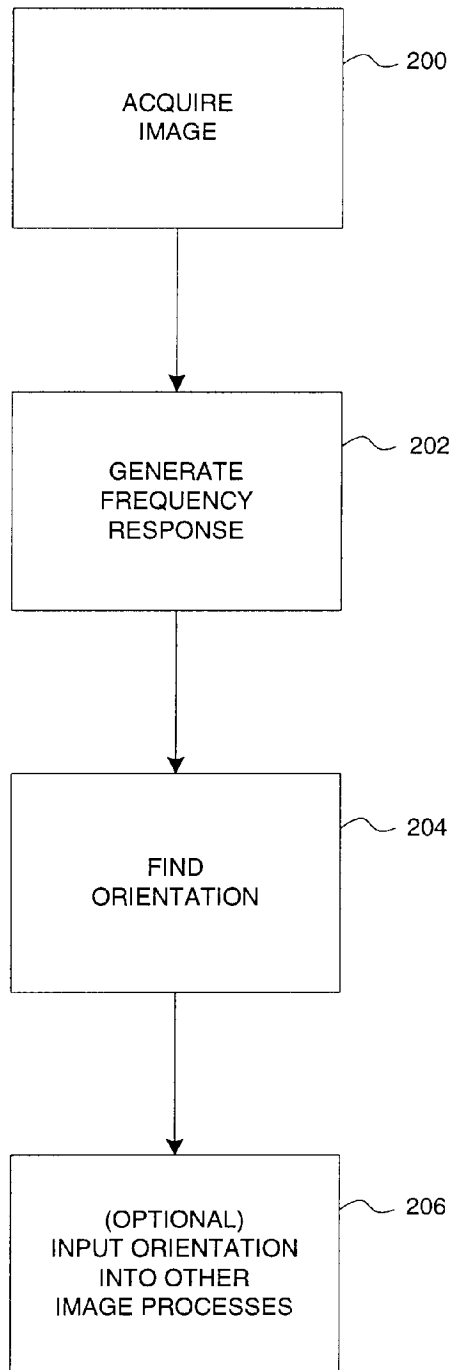

FIGURE 2

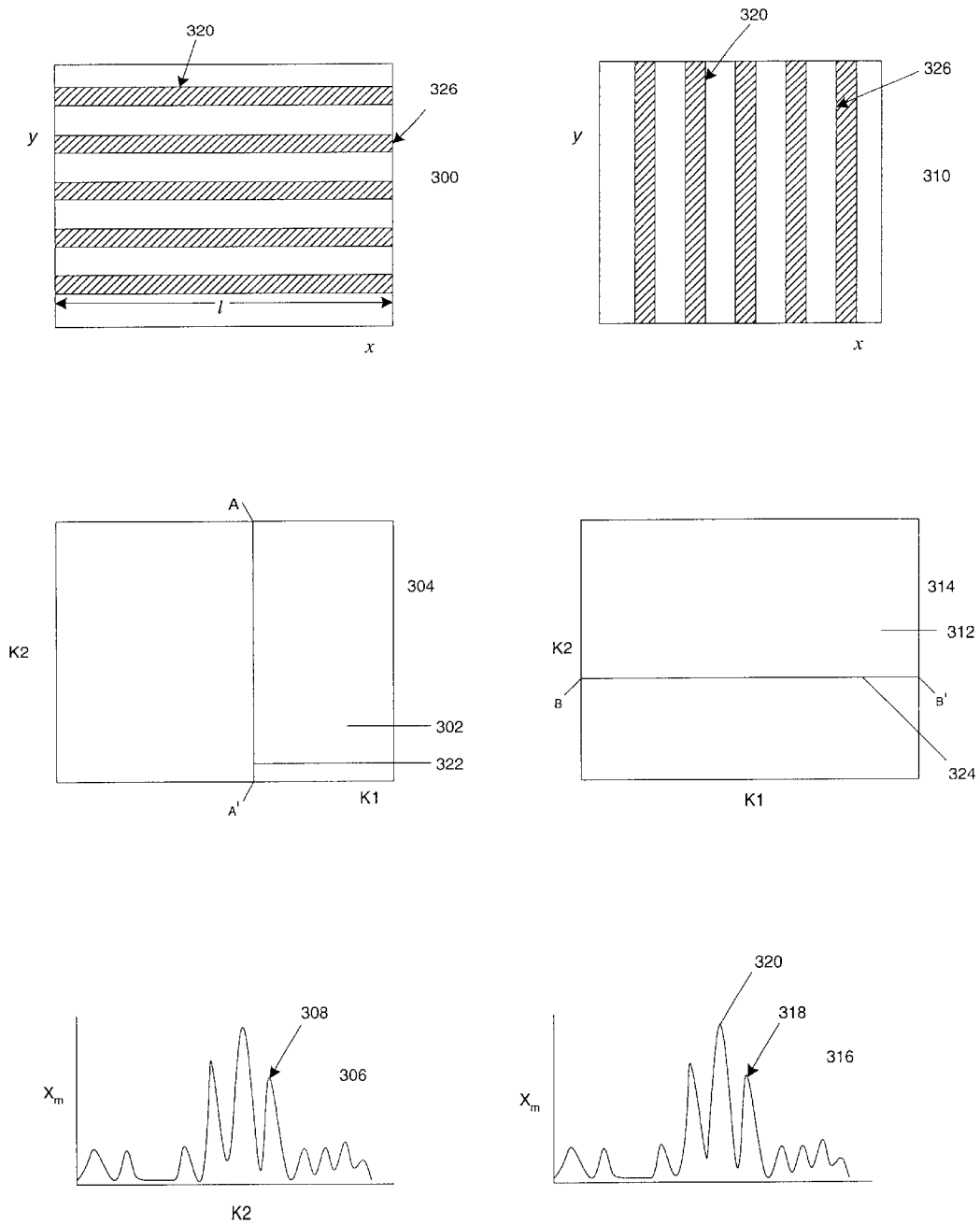

FIGURE 3

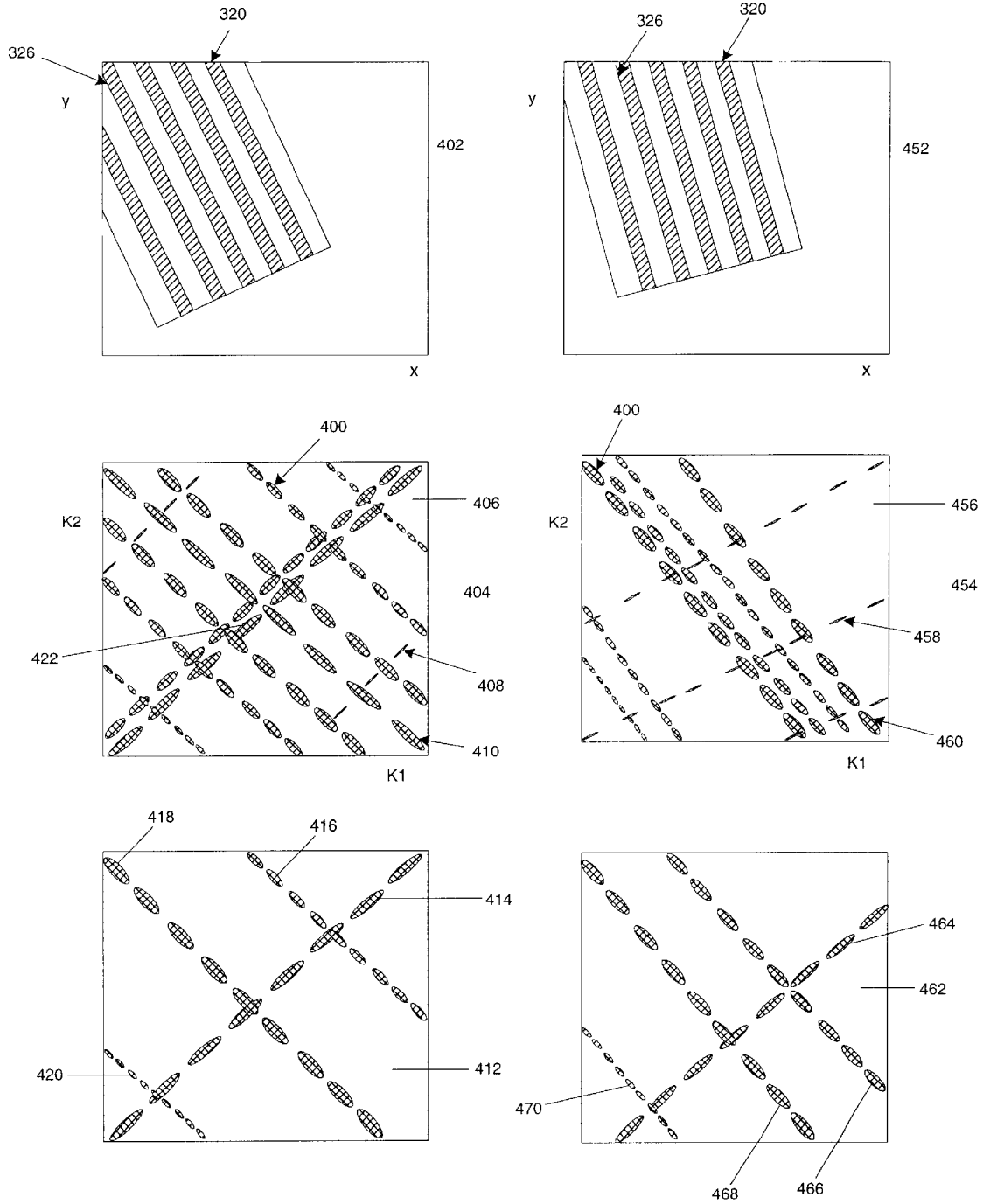

FIGURE 4

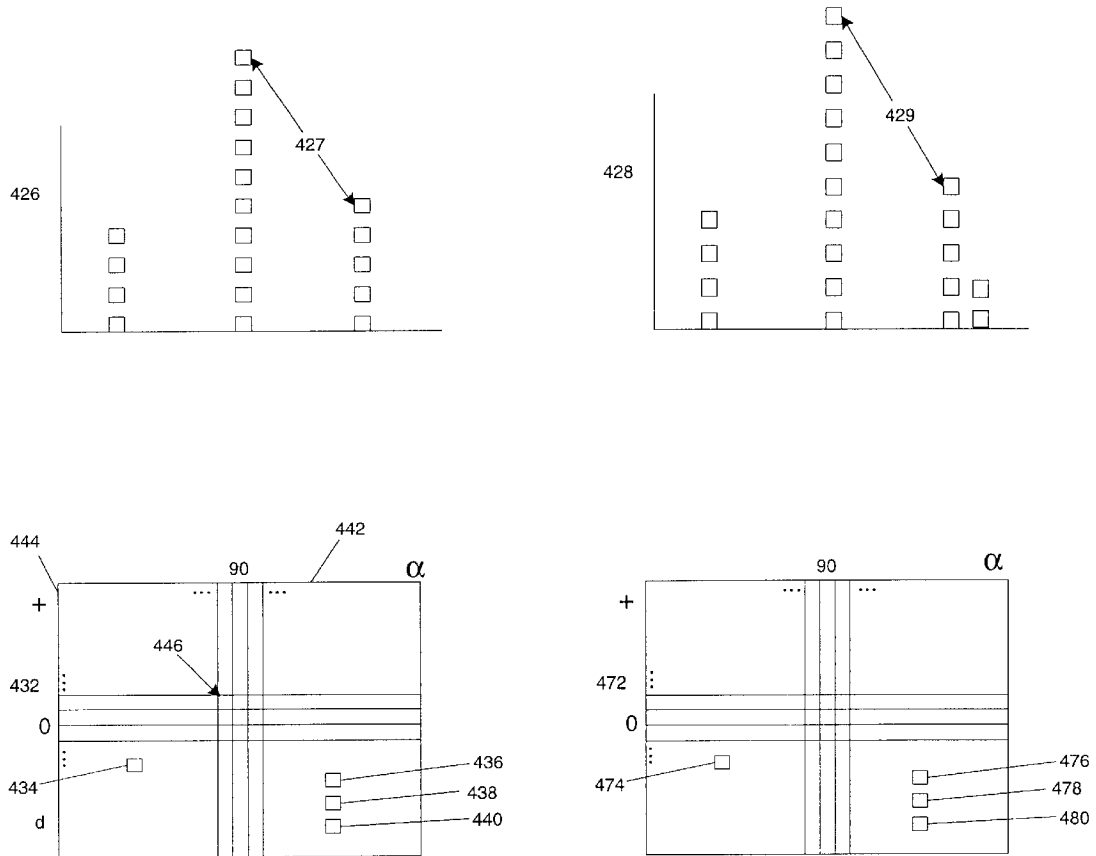

FIGURE 4
(CONT.)

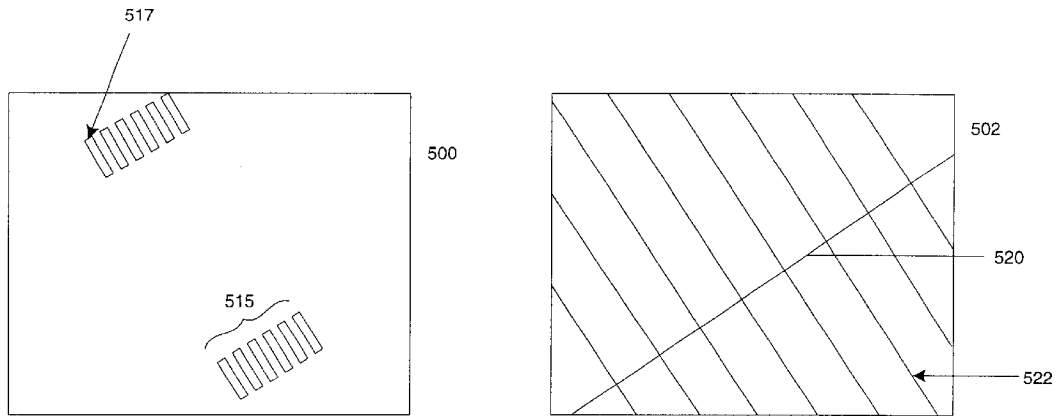

FIGURE 5A

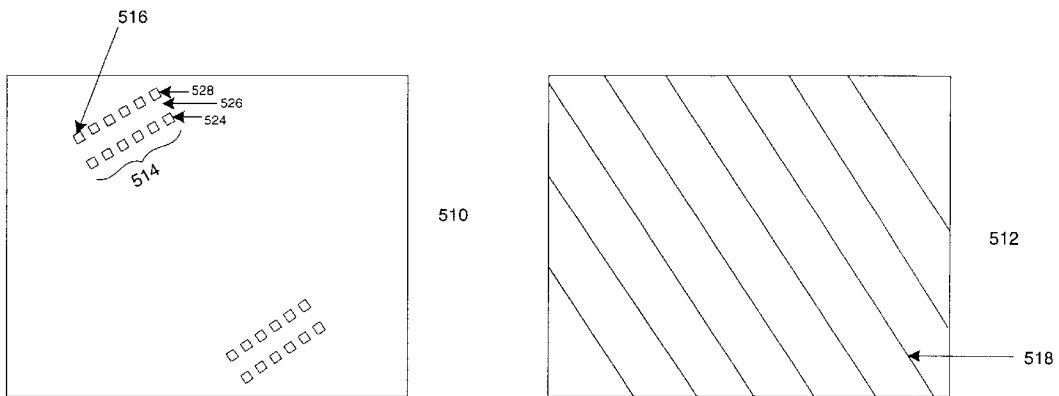

FIGURE 5B

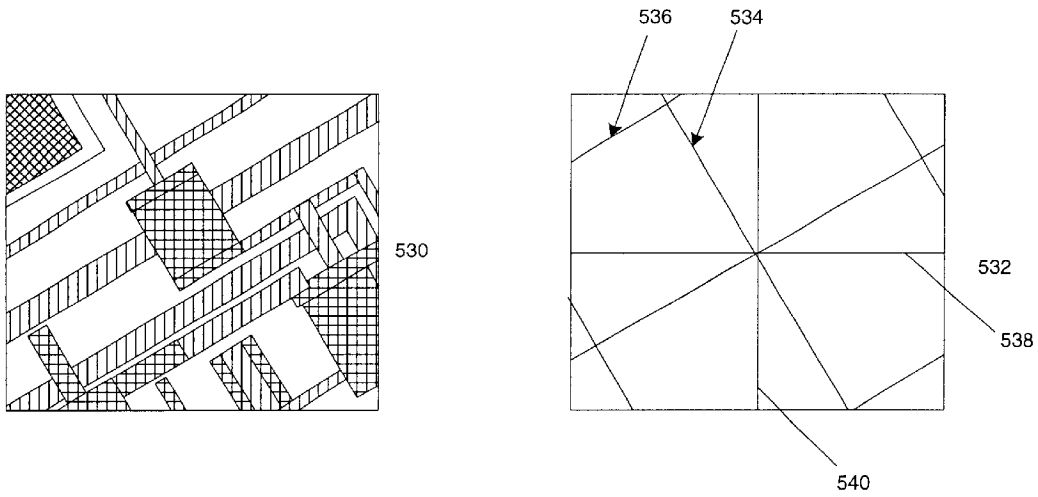

FIGURE 5C

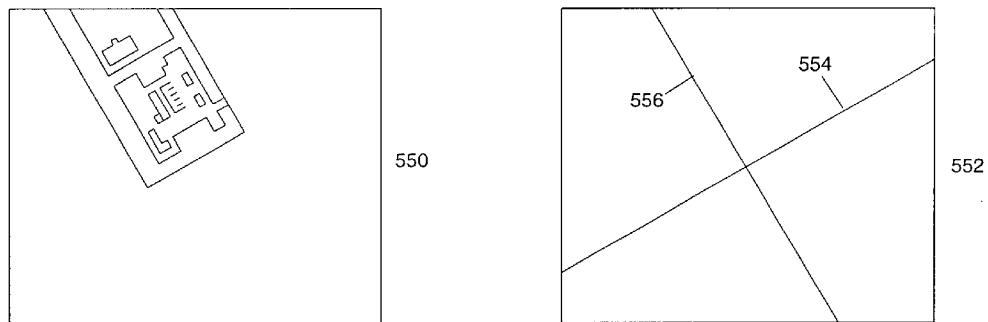

FIGURE 5D

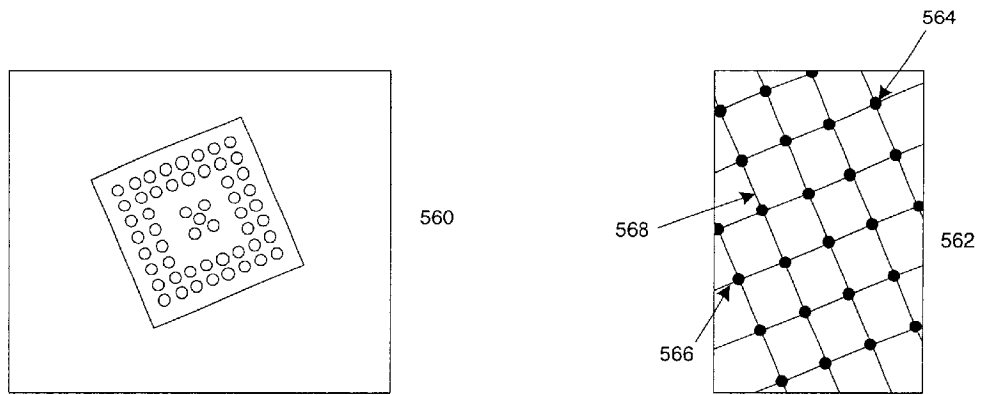

FIGURE 5E

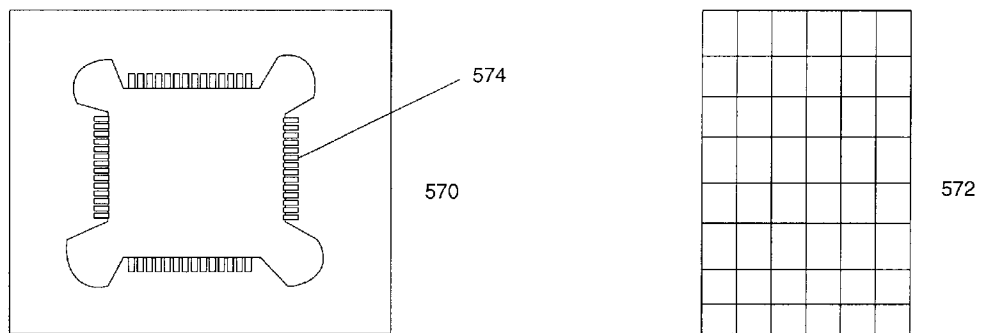

FIGURE 5F

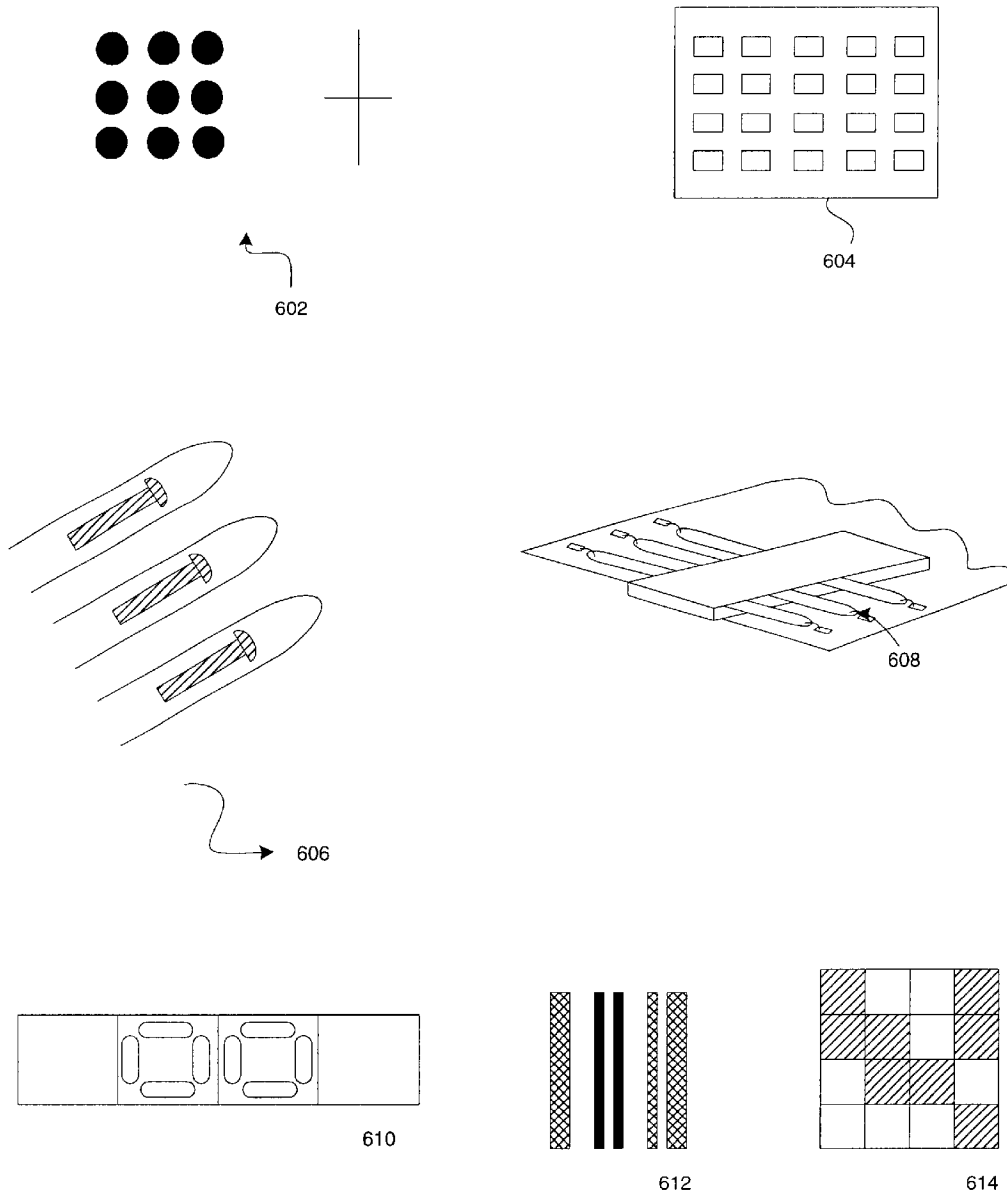

FIGURE 6

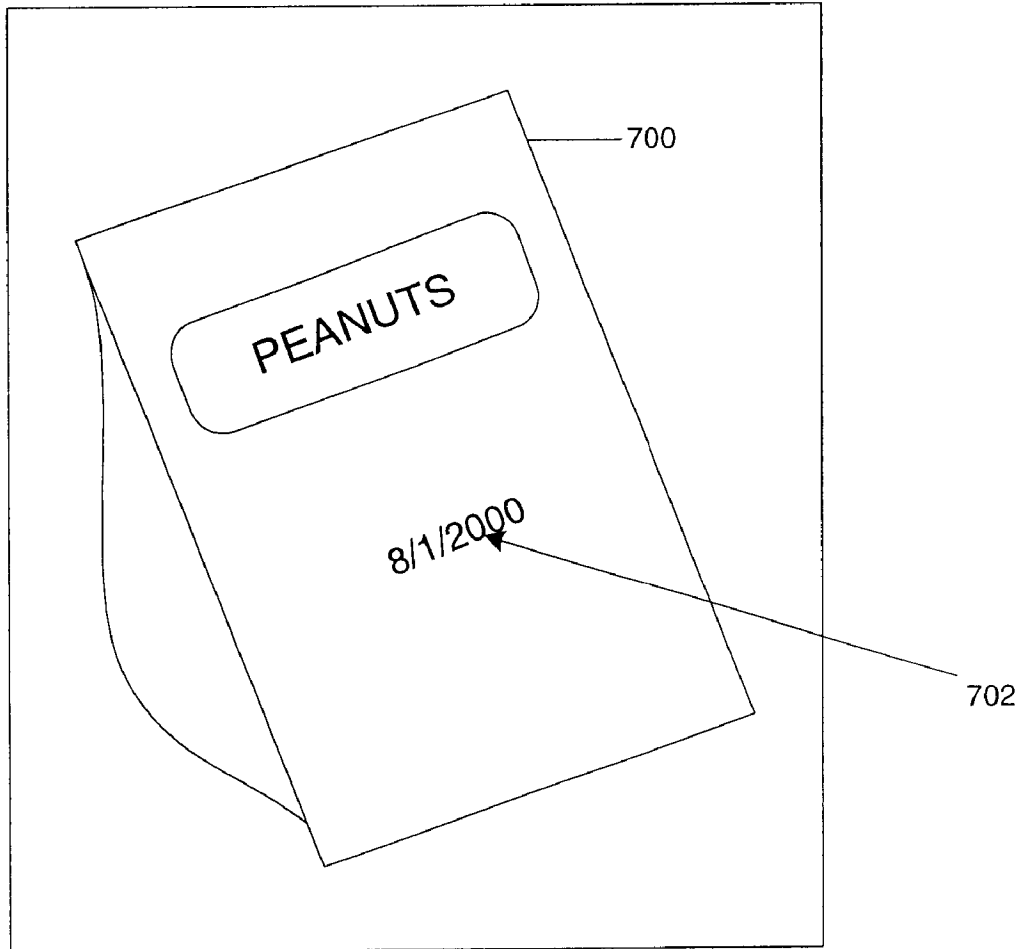

FIGURE 7

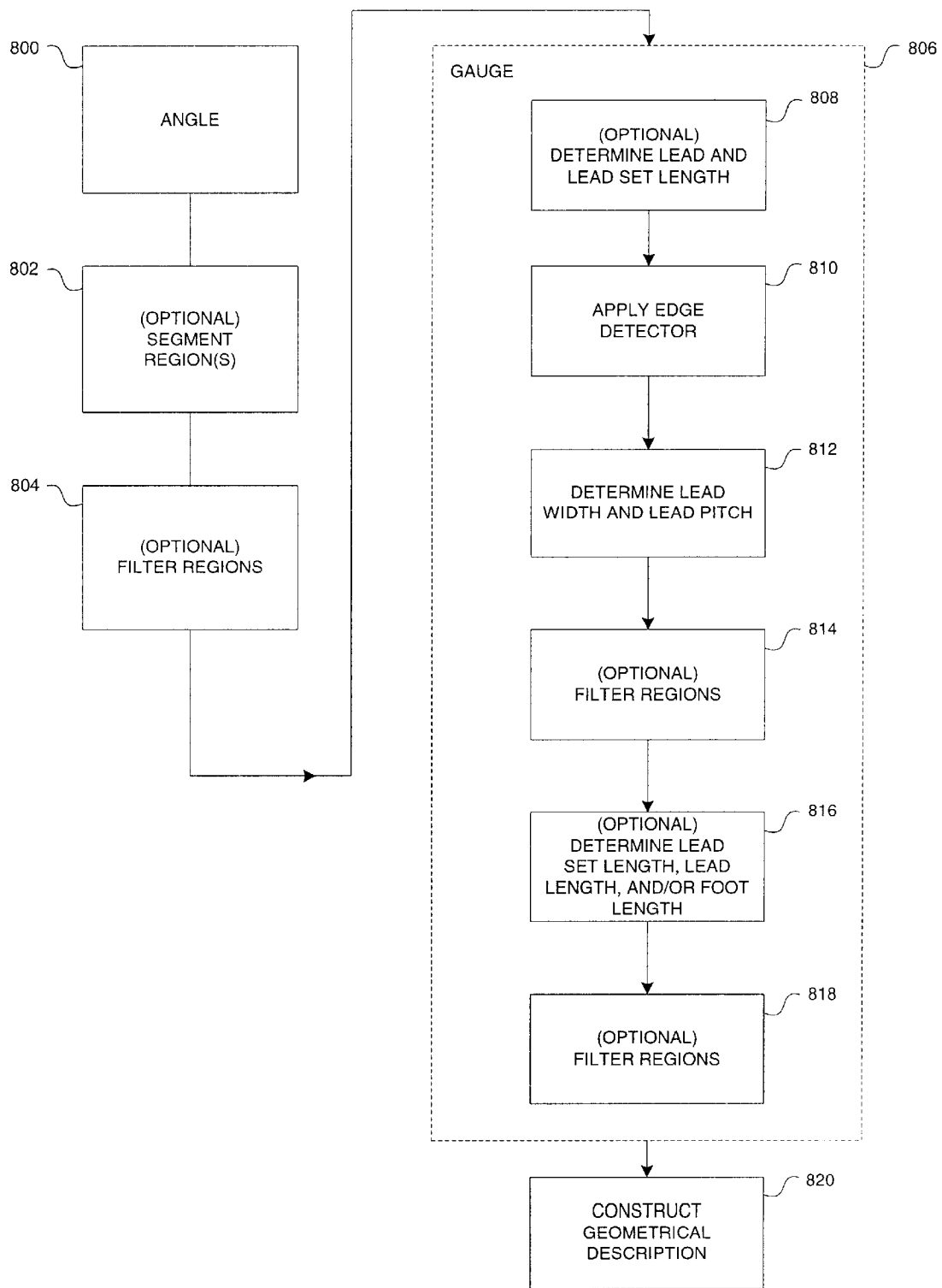

FIGURE 8

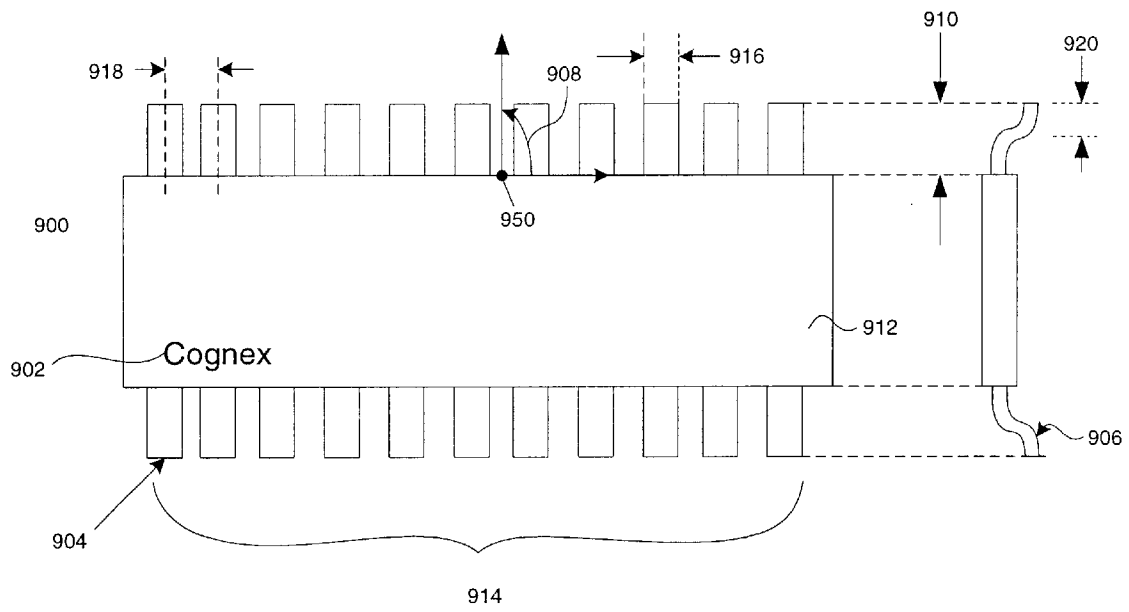

FIGURE 9

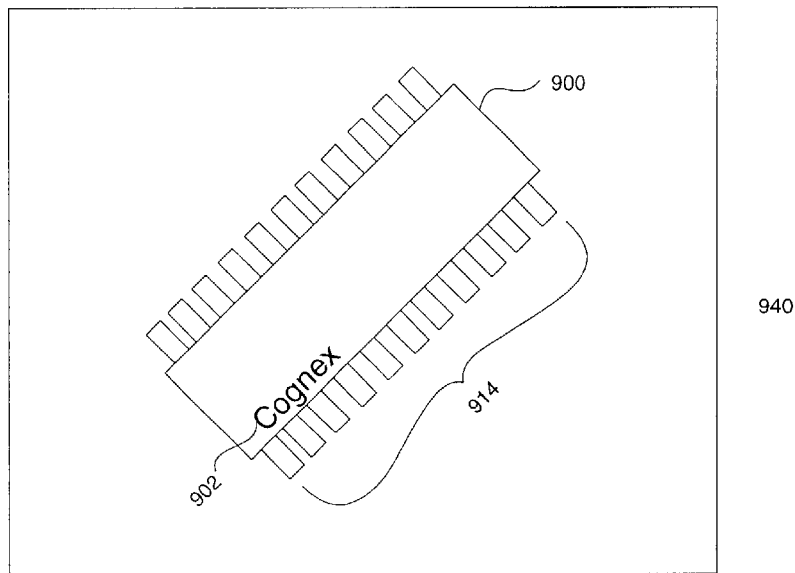

FIGURE 9A

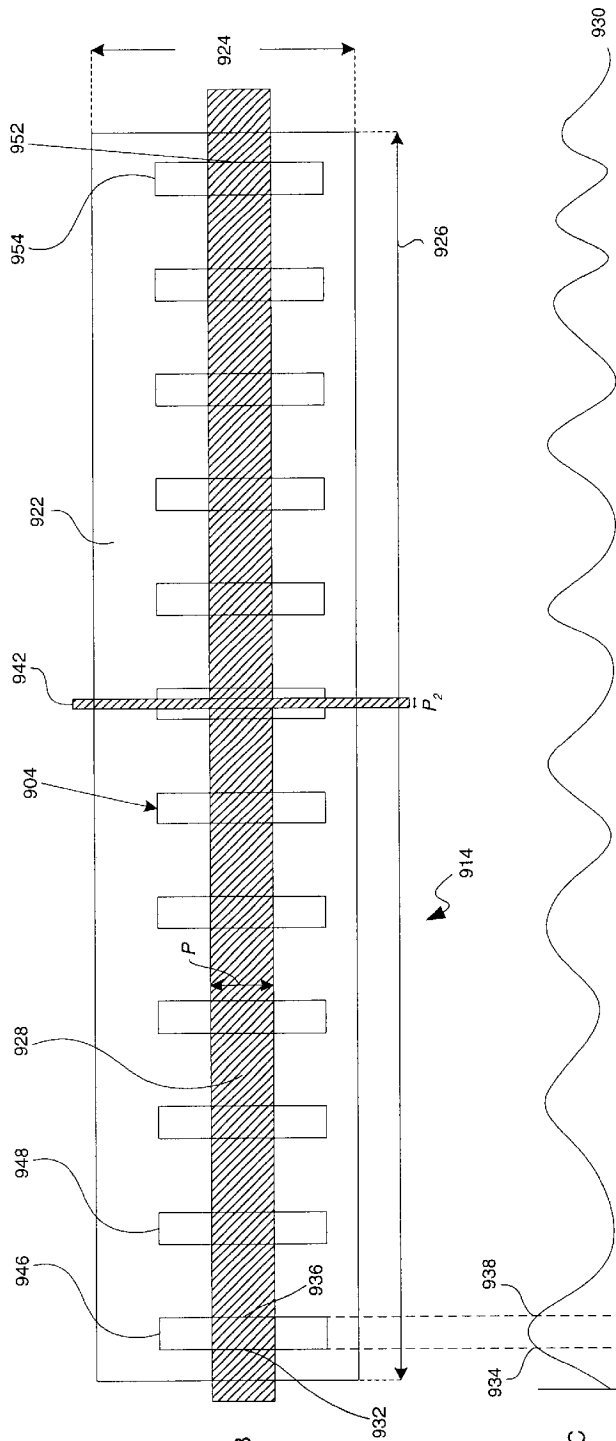

FIGURE 9B

FIGURE 9C

FIGURE 9D

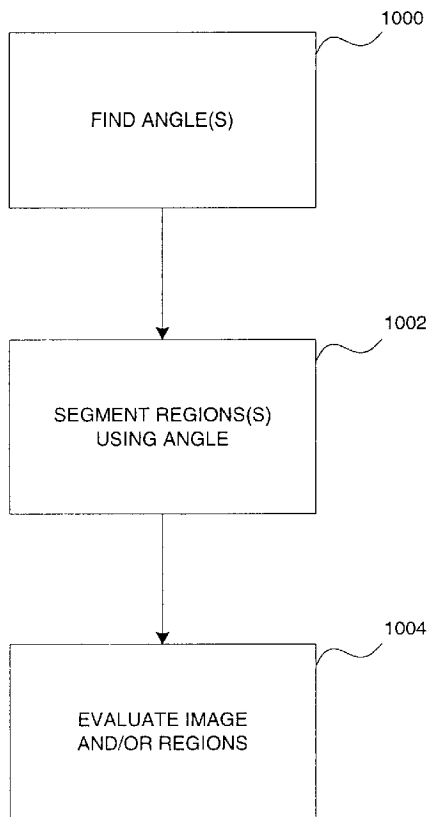

FIGURE 10A

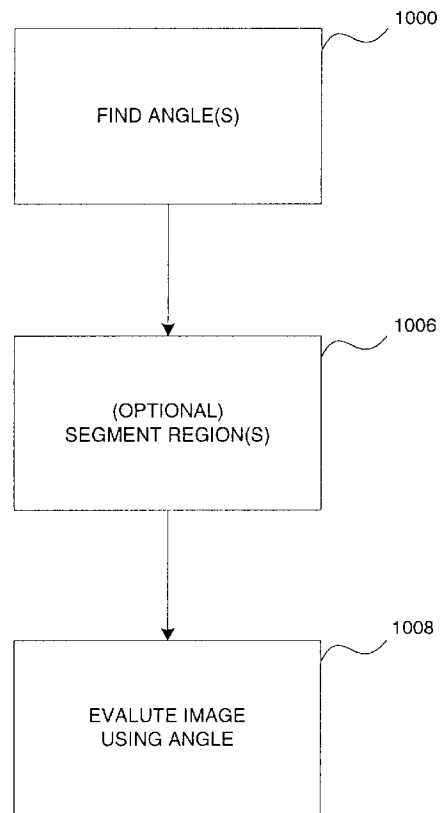

FIGURE 10B

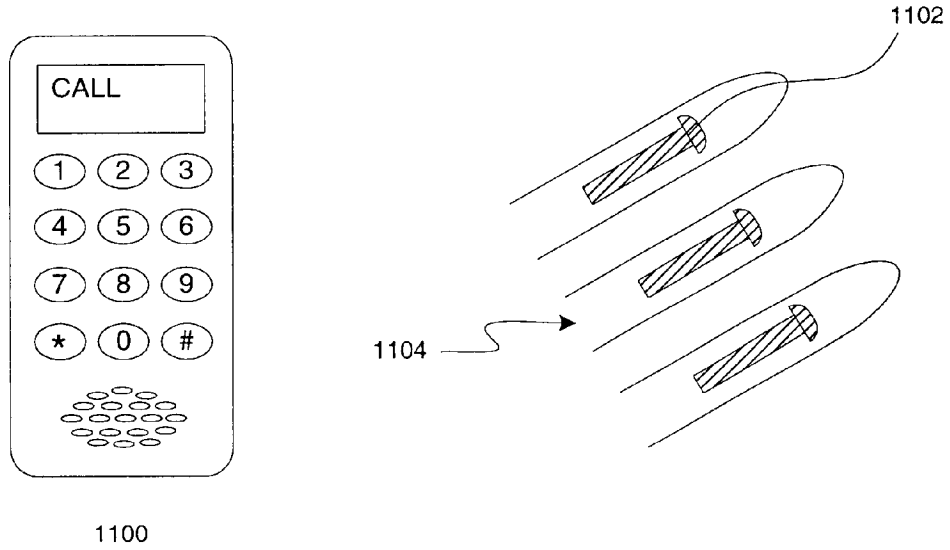

FIGURE 11

1

METHODS AND APPARATUSES FOR GENERATING A MODEL OF AN OBJECT FROM AN IMAGE OF THE OBJECT

This application claims the benefit of U.S. Provisional Application No. 60/147,721, filed Aug. 6, 1999.

FIELD OF THE INVENTION

This invention relates to machine vision, and particularly to methods and apparatuses for processing images.

BACKGROUND

Many machine vision systems use geometric descriptions as canonical models for inspecting or recognizing objects within images. A geometrical description is a collection of data that specifies the basic geometry of the object, that is the location of object features and dimensions of object features relative to each other. The features might include the object body, the number of extensions, or the number of lead sets, for instance.

The machine-vision system can use a geometrical model to locate an instance of an object in an image and align the object in the proper orientation (i.e., register the object). For example, a vision-based automatic surface mounter (SMD) machine typically employs a geometrical-based model of leaded objects to accurately inspect and place leaded objects on a printed circuit board (PCB). A leaded object **900** is an electronic component that has an object body **902** and leads **904**, an example of which is depicted in FIG. **9**, which is discussed more fully with reference to FIG. **8** hereinafter. The SMD machine places the leaded objects by registering the leaded object **900** with pads on the PCB, such that the centers of feet **906** of the leaded object **900** align with the centers of pads on the PCB within positional tolerances.

The process of creating accurate geometrical-based models of objects, either by manually measuring the dimensions of the object, or by extracting the dimensions from manufacturing specifications, can be very tedious, especially when the objects are complicated.

Not only is the creation of the geometrical description difficult, the task must be repeated for each object in a product; this makes changeover to new products on an assembly line very slow. For example, in addition to the surface mount leaded objects and through-hole leaded objects there are many types of ball grid array components, chips and all sorts of complicated odd-form objects, such as coils and connectors. A ball grid array is a surface-mount device consisting of a more-or-less rectangular package and a grid of balls. Further, new objects are continually being introduced. Therefore, a prior geometrical description cannot be reused without modification.

An alternative approach useful for some applications is to create featural models rather than models based on geometrical descriptions. A featural model describes the two-dimensional spatial arrangement of features, such as edges or corners, that constitute the appearance of an object. Featural models, however, require a large amount of processing memory, and an operator looking at the object cannot easily verify the correctness of featural models.

SUMMARY

This invention provides methods and apparatuses for generating a model of an object from an image of the object. First, an orientation of the object in the image is determined. Thereafter, the orientation is used to gauge the object. The

2

gauging provides the necessary dimensional information that becomes a part of the geometrical model of the object.

The orientation of the object is determined in two phases. First, a two-dimensional frequency response of the image, or portion thereof, is determined, and, preferably, represented in a frequency space, such as a two-dimensional plot or a frequency image, for example. Second, the frequency space is evaluated to determine an orientation of a spatial pattern therein. The invention recognizes, among other things, that the orientation of the spatial pattern within the frequency space is related to, and often equals, the orientation of the object in the image. More generally, the invention recognizes the frequency response of an image, or portion thereof, contains information about the orientation of objects in the image.

Further, the invention recognizes that once the frequency response, or portion thereof, is represented two dimensionally in a frequency space, whether plotted or within a frequency image, for example, and the frequency response, or portion thereof is preferably scaled to enhance the high frequencies, the orientation information is easily obtained from the frequency space using a variety of algorithms.

In one embodiment, the method segments regions of features on the object from the rest of the image before gauging the features. Optionally, the segmentation of the regions is accomplished using the orientation of the object. For example, in one embodiment, the orientation of a leaded object is used to segment the lead sets and gauge the leads with edge detection and calipers. The dimensional information produced is used to generate the geometrical description.

In further aspects, the regions of features, once segmented and/or gauged, are checked against validity norms, to determine whether the regions can be regions that contain features, where such checking includes: checking the area, shape, and/or number of regions, for example. Discarding regions that do not conform to validity norms saves time and/or often enhances the accuracy of the geometrical model.

The invention recognizes, among others, that the angle of the object can be used to segment regions and/or gauge the features of the object so that a geometrical model of the object can be created from an image of the object.

One of the advantages of the invention is that only easily obtainable input, an image of the object, is required from an operator, while the invention determines the difficult parameters of the geometrical description. Another advantage is that an operator's involvement is minimized and models can often be automatically generated from an image, saving time and enhancing accuracy. A further advantage of the invention is that it can be used over a wide range of objects.

In further aspects, the invention provides an apparatus in accord with the methods described above. The aforementioned and other aspects of the invention are evident in the drawings and in the description that follows.

BRIEF DESCRIPTION OF DRAWINGS

The invention will be more fully understood from the following detailed description, in conjunction with the accompanying figures, wherein:

FIG. **1** depicts a schematic machine vision system for practice of the invention;

FIG. **2** is a flowchart summarizing operation of an embodiment of a method according to the invention that determines the angle of at least one object and/or feature in an image;

3

FIG. 3 depicts the operation of applying a frequency analysis of FIG. 2 to two synthetically generated images;

FIG. 4 depicts the operation of FIG. 2 applied to two synthetically generated images;

FIGS. 5A, 5B, 5C, 5D, 5E, and 5F depict images of objects and/or feature(s), not drawn to scale, and a representation of the absolute value of a frequency response, or portion thereof, of the objects and/or feature(s);

FIG. 6 depicts objects and features, not drawn to scale, whose angle can also be determined using the method of the invention;

FIG. 7 depicts an image of object containing writing that can be evaluated using FIG. 2;

FIG. 8 is a flowchart summarizing operation of an embodiment of a method according to the invention that generates a model;

FIGS. 9, 9A, 9B, 9C, and 9D depict a leaded object, not drawn to scale, an image of the leaded object, an image of a portion of a lead set the leaded object, a histogram representing edges of the lead set, and a portion of an edge list derived from the histogram, respectively, where the leaded object and be modeled in whole, or in part, using the invention;

FIGS. 10A and 10B are flowcharts summarizing operation of an embodiment of a method according to the invention that uses the angle of at least one feature in an image to evaluate the image; and

FIG. 11 depicts features and objects, not drawn to scale, that can be modeled using the method of the invention.

DETAILED DESCRIPTION OF DRAWINGS

The methods and apparatuses determine the orientation of at least one feature in an image. The method is particularly useful for locating the angle of a lead set of a leaded object, which is then used in further aspects to generate a geometric model of the lead set and, optionally, the leaded object. Though this is the form of a preferred embodiment, this embodiment-should be considered illustrative, and not restrictive.

FIG. 1 illustrates a machine system 110 of the type in which the invention is practiced. The system 110 includes a capturing device 116, such as a conventional video camera or scanner, that generates an image of an object 112. Image data (or pixels) generated by the capturing device 116 represent, in the conventional manner, the image intensity (e.g. color or brightness) of each point in the scene at the resolution of the capturing device 116.

The capturing device 116 transmits image data via a communications path 118 to an image analysis system 120. This is a conventional digital data processor, or a vision processing system of the type commercially available, for example, from the assignee hereof, Cognex Corporation, programmed in accord with the teachings hereof to determine the angle of an object and/or feature in an image from the image data, and, generate a geometric model of the object and/or feature 112.

The image analysis system 120 may have one or more central processing units 122, main memory 124, an input-output system 126, and one or more disk drives (or other mass storage device) 128, all of the conventional type.

The system 120 and, more particularly, central processing unit 122, is configured by programming instructions according to the teaching hereof to generate a geometrical model of an object and/or features of the object in an image from the image data, by first finding an angle of the object and/or

4

features, and thereafter, gauging the object and/or features. The central processing unit 122 includes a frequency device 134, an orientation device 136, a gauging device 140, a modeling device 142, and optionally, a segmenting device 138. The frequency device 134 and the orientation device 136 generate a frequency response of an image, or portion thereof, and evaluate an angle of a spatial pattern(s), also called spatial-frequency pattern(s), present therein to provide the angle of the object and/or feature in the image, as described hereinafter. The gauging device 140, the modeling device 142, and optionally, the segmenting device 138 use the angle to generate a geometrical model of the object and/or features on the object, as described hereinafter. In one embodiment, the segmenting device 138 segments regions of interest from the image of the object, with or without using the angle, as described in further detail below. In one embodiment, a filtering module (not shown) filters the regions of interest, before, or during, gauging, as described hereinafter. Further, the gauging device 140 gauges the object and/or the features to provide dimensional information that the modeling device 142 uses to construct the geometrical model, as described in further detail below.

It should be apparent to one skilled in the art that devices within the central processing unit 122 can be partitioned in more than one manner without departing from the scope of the invention.

Those skilled in the art will appreciate that, in addition to implementation on a programmable digital data processor, the methods and apparatuses taught herein can be implemented in special purpose hardware.

FIG. 2 illustrates a flowchart of an embodiment of a method according to the invention, where steps of the method will be denoted in the detailed description in parentheses. The first step is to acquire an image of the object (200). Next, a frequency response of the image, or portion thereof, is generated (202). Thereafter, the frequency response, or portion thereof, is analyzed to determine the angle of an object and/or features in the image (204).

The frequency response is analyzed because, as recognized by the invention, the frequency response, or portion thereof, contains information about the orientation of objects in the image. More specifically, the invention recognizes that the frequency response, or portion thereof, contains a spatial pattern or patterns that is, or are, related to, and often the equivalent of, the angle of the object in the image.

Examples of specific frequency responses of images 300 and 310 of synthetically generated striped objects, herein after termed idealized object 320 are shown in FIG. 3, where the specific frequency responses 302 and 312, are a magnitude of the two-dimensional discrete Fourier transform ("2-D DFT") of the images 300 and 310. The frequency responses 302 and 312 are represented on a dual-axis frequency space 304 and 314, respectively.

The 2-D DFT is given by the following equations:

$$X(k_1, k_2) = \sum_{n_1=0}^{(N_1-1)} \sum_{n_2=0}^{(N_2-1)} x(n_1, n_2) e^{-j2\pi/N_1 k_1 n_1} e^{-j2\pi/N_2 k_2 n_2}$$

for $0 \leq k_1 \leq N_1 - 1$ and $0 \leq k_2 \leq N_2 - 1$.

$X(k_1, k_2) = 0$ for all other k_1 and k_2 .

$X(k_1, k_2)$ is the frequency response of the image, k_1 and k_2 are integers, and $X(k_1, k_2)$, at each k_1 and k_2 , is the value of the frequency response in a frequency space having K_1 and K_2 as frequency axes. The image is a discrete, two-dimensional function, given by $x(n_1, n_2)$, where n_1 and n_2 are

integers, and the value of $x(n_1, n_2)$ at each point (i.e., each n_1 and n_2) represents a shade of grey in the image. The image size is N_1 by N_2 where N_1 and N_2 are positive integers. The image has an y-axis and an x-axis.

The Fourier frequency analysis represents an image, $x(n_1, n_2)$, of size N_1 by N_2 , (i.e., an $N_1 \times N_2$ point sequence), in the frequency domain by $X(k_1, k_2)$, which is an $N_1 \times N_2$ point sequence.

Returning to FIG. 3, image 300, depicts the idealized striped object 320 positioned in the image 300 so that the dark stripes 326 extend horizontally across the image 300. At a single y-value, the image 300 does not change grey level along the x-axis. The frequency response, $X(k_1, k_2)$, 302, shown on the frequency space 304, reflects the lack of change in grey level of the striped object 320 along the x-axis. The x-axis of the image 300 contributes only to the DC component of the frequency response. Thus, frequencies are only present at the DC component along the K1-axis, specifically frequencies are present where k_1 =the DC component. Frequencies exist along the K2-axis and are shown in plot 306, which is a cross-section of the frequency space 304 at AA'. The plot 306 depicts the value of the frequency along the abscissa and the magnitude of the frequency, X_M , along the ordinate.

As known in the art, $X(k_1, k_2)$ is often complex and is expressed by a magnitude component, X_M , and a phase component, θ_x , or a real component, X_r , and a complex component, X_f .

In a preferred embodiment, the frequency response of the image that is generated is the magnitude, X_M , where $X_M = |X(k_1, k_2)| = \sqrt{X_r^2 + X_f^2}$. X_M is a measure of the strength of the spatial frequencies present in the image, and the strength is represented by the height of the peaks 308 in the plot 306, and is also represented by the brightness or darkness of the features in the frequency images described hereinafter. Peaks, as used herein, exhibit higher magnitudes of frequencies relative to the background level.

In contrast to image 300, image 310 depicts the same idealized striped object 320 positioned differently, so that the dark stripes 326 extend vertically across the image 310. At a single x-value, the image 310 does not change grey level along the y-axis. Accordingly, the frequency response, $X(k_1, k_2)$, 312 is only present at one point along the K2-axis, specifically, frequencies are present where k_2 =the DC component, while multiple frequencies exist along the K1-axis and are shown in plot 316, which is a cross-section of the frequency space 314 at BB'. The plot 316 depicts the value of the frequency along the abscissa and the magnitude of the frequency, X_M , along the ordinate.

FIG. 4 depicts two images 402 and 452 of the same striped object 320 positioned to provide changes in grey values in both x- and y-directions within the images 402 and 452. Accordingly, there are components present in both K1- and K2-directions within the frequency responses 406 and 456 as depicted in the frequency spaces 404 and 454 of the images 402 and 452, respectively.

As the striped object 320 moves, the frequency response changes, and the peaks within the frequency response move. For example, the position of the peaks 400, in the frequency response 406 are displaced from the peaks 400 in the frequency response 456. Specifically, the frequency response 406, to the object positioned at 45°, has peaks 400 that are generally displaced to the right of, and higher than, the peaks 400 in the frequency response 456, to the object positioned at 200°.

The position of the peaks 400 will move relatively as the striped object 320 changes direction, because when striped

object 320 moves, the 2-D DFT responds more strongly to a different set of frequencies than the 2-D DFT responded to before the striped object 320 moved. In general, frequency is a measure of change in space or in time. Spatial frequencies of an image are the measure of the rate of change in grey level across an image. Such grey level changes are typically caused by edges. When the edges of the objects move, the frequency response of the image changes accordingly.

The same striped object 320, positioned four ways, in four images 302, 310, 402, and 452, generated four different frequency responses 302, 312, 406, and 456, respectively. The frequency response 302 of the image 300, wherein the stripes 326 are horizontal, is a vertical line 322. The frequency response 312 of the image 310, wherein the stripes 326 are vertical, is a horizontal line 324. The frequency response 406 of the image 402, wherein the stripes 326 are positioned at 45°, appeared on the frequency space 404 as two sets of parallel lines 408 and 410, one set of parallel lines 408 positioned at 45° and one set of parallel lines 410 positioned at 135°. The frequency response 456 of the image 452, wherein the stripes 326 are positioned at 20°, appeared on the frequency space 454 as two sets of somewhat parallel lines 458 and 460, one set 458 positioned at approximately 20° and one set 460 positioned at approximately 160°.

All the frequency responses 302, 312, 406, and 456 are related to the angle of the idealized object 320 and the angle of the striped features 326 in the images 300, 310, 402, and 452, respectively. More particularly, the lines, such as 322, 324, 408, 410, 458 and 460 (i.e., the spatial patterns), of the frequency responses 302, 312, 406, and 456 share, or are at a constant offset from, the angle of the idealized object 320 and/or the stripes 326. For instance, for the frequency response 406, the two sets of parallel lines 408 and 410 reflect the sides, and ends, of the stripes 326 (i.e. features), respectively. Therefore, the angle of the set of parallel lines 408 in the frequency space 404 is substantially equivalent to the angle of the width, w , of the stripes 326 in the image 402, and the angle of the set of parallel lines 410 in the frequency space 404 is substantially equivalent to the angle for the length, l , of the stripes 326 in the image.

The magnitude of the frequencies, and thus, that of the peaks 400 can be depicted in numerous manners, including by graphing the frequency response along a cross section of the frequency spaces 404 and 454, similarly to plots 306 and 316 of the horizontal and vertical idealized objects 320.

The invention recognizes that the magnitude of the frequency response, or portion thereof, of an image, contains a spatial pattern or patterns, and that the angle of the spatial pattern or patterns is related to, and often the equivalent of, the angle of the object in the image. The angle of the spatial pattern is related to the object by being at a constant offset from the angle of the object and/or features on the object.

FIGS. 3 and 4 each depict one instance of the frequency response, or portion thereof, of the same idealized object 320 positioned at a given angle.

However, in manufacturing conditions, more than one instance of a frequency response to the same object is possible. This effect can be illustrated, in part, by FIGS. 5A and 5B, not drawn to scale, which depict two images 500 and 510 of a pair of lead sets, positioned within each image 500 and 510 at the same angle, and representations of the corresponding frequency responses 502 and 512. In image 510, each lead 516 has three regions, 524, 526, and 528. The presence of three regions is a typical effect caused by the specularly reflecting surface of the leads 516, where the specular reflections cause images of leads to display variations in brightness levels. Specular reflections from leads

and the effects on images are well known in the art. For illustration purposes, the image **510** of the lead sets **514** is idealized so that each of the leads **516** is shown exhibiting the same three regions **524**, **526**, and **528**. The second idealized image, image **500** of the lead sets **515** shows an image **500** that is not effected by specular reflection, so that each of the leads **517** images as one region. Although both images **500** and **510** are of two 6-leaded lead sets **514** and **515**, positioned at the same angle, the frequency responses **502** and **512** are different. The frequency response **512** of the image **510**, containing the specularly reflecting leads **516**, is one set of parallel lines **518**, while the frequency response **502**, of the image **500**, of the non-specularly reflecting leads **517**, is a set of parallel lines **522** and a line **520** positioned orthogonal thereto.

Additionally, a spatial pattern within a frequency response can be due to factors other than the object or its features, such as the windowing of the image, where windowing is a term known in the art. For example, FIG. **5C** depicts an image of a circuit board **530**, not drawn to scale, and a representation of a corresponding frequency response, or portion thereof, **532**. The frequency response **532** contains eight lines sharing four angles, two sets of parallel lines **534** and **536** are related to the angle of the features on the circuit board, and two other lines **538** and **540** are related to the windowing of the image **530**. The lines **538** and **540** are part of two sets of parallel lines (not shown) sharing the angles of 0° and 90° . The other parallel lines had less intensity and were omitted for illustration purposes.

Further still, the frequency response can be a single line at each angle, as opposed to a set, or sets, of parallel lines. For instance, FIG. **5D** illustrates an image **550** of a top-view of a portion of an integrated circuit board, not drawn to scale, and a representation of the corresponding frequency response, or portion thereof **552**. The integrated circuit board has several features, or portions thereof, aligned at approximately 30° and 120° . The frequency response **552** is two single lines **554** and **556**, orthogonal to one another, as opposed to one or more sets of parallel lines. Returning to FIG. **3** previously described, the frequency responses **302** and **312** are other examples where the spatial pattern is a single line **322** and **324**, respectively.

Another example of a frequency response is the discrete circles shown at the intersections of the lines in FIG. **5E**, which depicts an image of a ball grid array and a representation of a corresponding frequency response, or portion thereof.

In one embodiment, to decrease processing requirements, only part of the frequency response is calculated and/or evaluated in step **(204)**.

Also to decrease processing time, in a preferred embodiment, a two-dimensional discrete fast Fourier Transform of the image is computed, using techniques known in the art.

It should be apparent to those skilled in the art, that other discrete signal analysis techniques, such as z-transforms and cosine transforms, can be used in accordance with the teachings herein without departing from the scope of the invention. One skilled in the art, using the teachings herein, can easily verify which frequency analysis tools are useful, and the list given here is not inclusive.

Further, although the two-dimensional analysis described herein was in the x- and y-direction, other spatial representations can also be used, such as radial and circumference directions of r and θ without departing from the scope of the invention.

Further still, the frequency analysis can be applied to more than two dimensions. For instance, a three-

dimensional image signal (i.e. a signal that is a function of x , y , and z , for example) can be evaluated using the teachings herein, such as applying a three-dimensional discrete Fourier Transform. In this way, frequencies along the z -direction are examined. The three-dimensional image signal is constructed as known in the art; such as by building a three-dimensional object representation from two-dimensional slices of the object, for example.

Once the frequency response, or portion thereof, is generated, the spatial pattern within the frequency response, or portion thereof, is evaluated for the orientation information **(204)**.

Returning to FIG. **4**, for illustration purposes, the frequency response, or portion thereof **406** and **456**, is represented graphically within a two-dimensional frequency space **404** and **454**, respectively. The frequency spaces **404** and **454** contain plots of values of the frequency responses or grey-scale images representing the frequency responses **406** and **456**, respectively.

When the frequency response is represented within an image, the frequency response is mapped to a grey-scale value in the image between 0 and 256. It is preferred that the grey values in the frequency image are mapped so that the low grey values represent low magnitudes in the frequency response and high grey values represent high magnitudes in the frequency response. It should be apparent that other mappings can be used, such as using the period, as opposed to the frequency, or mapping the high magnitudes using the low grey values, and the low magnitudes using the high grey values, for example. For illustration purposes, the figures used herein map the high magnitudes in the frequency response using the low grey values and the low magnitudes in the frequency response using the high grey values, so that the peaks of the frequencies **400** appear as darker features within the frequency images.

In a preferred embodiment, before the frequency space is evaluated, the stronger DC peak and other low frequency peaks, such as peak **422** on FIG. **4** or peak **320** on plot **316** of FIG. **3**, within the frequency response, or portion thereof, are minimized and/or the higher frequencies are enhanced using a scaling factor. Preferably, the frequency response, $X(k1, k2)$, is scaled using a logarithmic function, such that the frequency image is mapped from the function $F(x,y)$, where $F(x,y)=\log |X(k1, k2)|$, and $X(k1, k2)$ as given above. The logarithmic function decreases the effect of the stronger DC peak and other low frequency peaks, and, thus, allows easier analysis of the smaller peaks. It should be apparent to one skilled in the art that other scaling functions can be used, such as raising $X(k1, k2)$ to a fraction of a power, for example.

Optionally, the frequency response is filtered to minimize and/or remove extraneous data before the frequency response is evaluated. Frequency response **412** is an example of an instance of the frequency response **406** after being scaled and filtered, and frequency response **462** is an example of an instance of the frequency response **456** after being scaled and filtered. The filtering is accomplished by one of any number of vehicles known in the art. For instance, only the data points above a value threshold are retained for a plot or only data points above a grey value threshold are retained for an image. Alternatively, an edge operator is applied to a frequency space and the data points retained are only edges above a contrast threshold, or only "true peak" edges, for example, where edge operators and "true peaks" are terms and techniques known in the art.

The invention recognizes that a variety of algorithms can determine the angle of the spatial pattern(s) once the fre-

quency response, or portion thereof, is represented two dimensionally in a frequency space, whether plotted or within a frequency image, for example, and the frequency response, or portion thereof, is preferably scaled and, optionally, filtered to enhance the high frequencies.

A variety of algorithms can analyze the frequency response, or portion thereof, to find the angle of the spatial pattern(s). For example, the angle of pattern(s) is found using projections. With this technique, the frequency image is projected at a plurality of angles to create a one-dimensional (“1-D”) array for each of the angles, where 1-D projections are a technique known in the art, and further described in Cognex 300/400/500, Image Processing, Programmable Vision Engines, Revision 7.4 (1996) pp. 343–347. The 1-D arrays are evaluated for peaks, and the angle(s) of the projections producing higher peak(s) are the dominant angle(s) of the features in the image. For example, FIG. 4 depicts an instance of a 1-D array 426 formed from the projection of the frequency image 412 at 135°. Projecting the frequency image 412 at 135° produced high peaks, such as peaks 427. Thus, 135° is a dominant angle of the features (i.e., the lines) in the image 412. Also shown is an instance of a 1-D array 428 formed from the projection of the frequency image 462 at 160°. Projecting the frequency image 462 at 160° produced high peaks, such as peaks 429. Thus, 160° is a dominant angle of the features (i.e., the lines) in the frequency image 462. Those skilled in the art will appreciate that the peaks 427 and 429 represent portions of the 1-D array that exhibit a higher density of projected-grey levels relative to the background level thereof. Those skilled in the art will also realize that a different measure for the dominant angle could be used, such as the angle that produced the highest peak, the most high peaks, or other similar measure without departing from the scope of the invention.

Although empirically the patterns found have been lines or discrete circles, such as the discrete circles of FIG. 5E, other objects could generate other patterns within the frequency space. For such patterns, either the spatial pattern would need to be identified in order to choose the algorithm to evaluate it, or an algorithm that is not dependent on shape would be used, such as projection for certain objects.

An additional method for identifying lines, and the angle of the lines, from images has been described in commonly assigned, U.S. Pat. No. 6,075,881, incorporated herein by reference.

A still further method for identifying lines and the angle of the lines is applying a Hough-line finding algorithm. A Hough space for lines is a two-dimensional space in which lines from an image are recorded. The Hough space is adequately represented as a two-dimensional array of bins 446. One axis 442 represents the line-angle, α , and the other axis 444 represents the distance vector, d , which is the shortest distance from the origin of a coordinate system to the line. A point on a Hough space represents a line. Every data point from the frequency image “votes” into an accumulator array in the Hough space. The bins 446 with sufficiently many votes are identified as lines. For example the lines 414, 416, 418, and 420 are identified as peak bins 434, 436, 438, and 440, respectively, in a Hough space 432, and lines 464, 466, 468, and 470 are identified as peak bins, 474, 476, 478, and 480, respectively, in a Hough space 472. The bin with the most votes represents the strongest line.

Many other angle finding techniques can be used to find the angle of the spatial pattern without departing from the scope of the invention. Further still, if the frequency space is filtered before evaluation of the angle of the spatial

pattern(s), the data points on the frequency space may be altered, such as binarized or represented by edges, for example. Therefore, the utility and efficiency of any particular angle finding technique may vary depending on the filtering technique used, and/or the representation of the frequency response in the frequency space, such as by grey level or scaled grey level, for example.

Often more than one spatial pattern is identified within the frequency response. In a preferred embodiment, the angle of all the spatial patterns are considered in subsequent processes. In another embodiment, the angle of the strongest pattern is used, such as the angle of the projection that produced the highest peak. In another embodiment, the spatial patterns are weighted, and a dominant pattern is determined from any combination of the strength, that is number of features along pattern, and/or the weighted value of the pattern. Weighting is accomplished using one of many methods known in the art, and aspects of the lines are weighted according to numerous schemes without departing from the scope of the invention. For instance, a simple weighting scheme is identifying as the dominant line, the line having a dominant frequency, after the frequency response has been logarithmically scaled to minimize the effect of the DC peak and other low frequency peaks. Alternatively, the lines are weighted based on density and/or length, for example.

The invention recognizes that a spatial pattern, specifically a line, within the frequency space has an angle in the frequency space that is equivalent to, or at a constant offset from, the angle of an object and/or features in the image.

For example, the angle of at least one of the lines in the frequency space will equal the angle of the length of the leads of a leaded object, as can be seen by examining FIG. 5B, previously described herein. However, depending on how the angle of the leaded object is defined, the angle of the lines in the frequency space will be positioned 0° or 90° offset from the angle of the leaded object. For instance, if the angle of the leaded object is defined as angle 908 depicted in FIG. 9, the angle of the lines in the frequency space are offset 0° from the angle of the leaded object 900, and if the angle of the leaded object is defined as being along the horizontal axis, the angle of the lines in the frequency space are offset 90° from the angle of the leaded object.

Depending on the object or features, the angle does not indicate the direction of the object. For example, the angle, derived as herein described, for the lead sets of FIG. 5B, previously described, is 130° and 310°.

Accurate and quick angle information is obtained particularly for objects that have features that repeat or for repeated objects positioned at the same angle, which is advantageous in many post-processing applications. Turning to FIG. 6, not drawn to scale, examples are certain calibration targets 602 with repeating features, pads on a circuit board 604, liquid crystal displays 610, a group of crescent bonds 606, a group of wires in a bonding application 608, two-dimensional ID codes 614, leaded objects, such as surface mount and through hole components, and ball grid arrays, for example.

It should be apparent that angle of other objects without repeating features, are also amendable to being evaluated, such as a bar code 612, some of the calibration targets 602, or writing 702, shown in FIG. 7, described further hereinafter, for example. Another example is depicted in FIG. 5D, previously described, which shows an integrated circuit board, having several features or portions thereof aligned at approximately 30° and 120°, not drawn to scale. The angle of approximately 30° and 120° is ascertained even though the features are not uniform or regularly spaced, as

11

in the case of leads, and even though each feature does not contribute equally to the angle (some features contribute edges from both sides of the features, while others features contribute edges only from one side).

In general, many objects that have at least portions of the object and/or features oriented in a general direction can be analyzed using the method of FIG. 2.

Typically, determining the angle of the object in the image does not complete the image analysis. The angle, optionally, becomes input into subsequent image processing or analysis (206). It should be apparent that any type of post-processing can be implemented using the angle derived as described herein without departing from the scope of the invention. The angle can also be one of several desired outputs instead of, or in addition to, being input for further processing.

Knowing the angle of the features and/or object removes one variable from a vision task. Now, instead of performing a vision task where attention is paid to translation, rotation, and scale, only variations in translation and scale need to be accommodated. For instance, searches are often performed by making a model of the feature to be found, and searching the image at a plurality of angles and positions for a match of the model to a portion of the image. If scale is variable, this process is repeated at various scales. However, if the angle is predetermined, the search is executed more quickly because all possible angles of the model do not need to be examined. For example, if the vision task was character recognition of a freshness date 702 on an individual pack of peanuts 700 depicted in FIG. 7. The angle, computed as previously described, is 45° and/or 135°. Thereafter, the search model is not tested against the image at other angles, decreasing the search time, and improving time of performance of the character recognition.

It should be apparent that the angle information can be leveraged in any location, gauging, inspecting, training, or modeling procedure, for example. For instance, FIGS. 10A and FIG. 10B are flowcharts summarizing operation of an embodiment of a method according to the invention that uses the angle(s), derived as previously described, to evaluate the image, where steps of the method are denoted in the detailed description in parentheses. In one embodiment depicted in FIG. 10A, the angle (1000) is leveraged to segment one or more regions of interest from the image (1002) by using a segmenting technique that uses, or is quicker given, the angle, where segmenting a region of interest of an image is a typical technique used during image processing. One example of a segmenting technique that uses, and/or is quicker given the angle is using projection along the angle, or at an offset thereto, to measure the extents of a region along that angle, or offset thereto. An additional example of a segmenting technique is given below. Thereafter, the regions of interest and/or the remainder of the image is evaluated (1004), where again the evaluation can include gauging, inspecting, training, or modeling, for example. Another embodiment is depicted in FIG. 10B. First, the angle is provided (1000). Then, one or more regions of interest are optionally segmented, with or without use of the angle (1006). Next, the regions of interest and/or the remainder of the image is evaluated by leveraging the angle (1008). Again, the evaluation is gauging, inspecting, training, or modeling, for example, where the evaluation requires, or is made more efficient, when provided, the angle of the object and/or features in the image.

In a preferred embodiment, the angle is input (800) into a modeling procedure illustrated by the flowchart of FIG. 8, where steps of the method are denoted in the detailed description in parentheses. FIG. 8 describes a method that

12

outputs a geometrical description of an object and/or features of an object given the angle of the feature and/or object, where the angle is derived as previously described.

The angle (800) is leveraged in the segmenting step (802), and/or the gauging portion (806) of the modeling task.

Numerous methods can be used to segment the regions of interest from the image, with, or without, using the angle. In one embodiment, the regions are segmented (802), without using the angle information, by determining a threshold grey value that separates the background from the regions of interest, which is a technique known in the art. As commonly understood by those trained in the art, determining a threshold to binarize the image is a difficult task in connectivity analysis. A threshold value that is too large will remove too much information from the image, and a threshold value that is too small will retain unwanted information.

Therefore, one technique to segment a region, such as a lead set, chooses a threshold using an aspect of the regions, such as shape, in conjunction with an iterative process, as is further described in co-pending U.S. application, Ser. No. 09/605,441 entitled, "Methods and Apparatuses for Generating from an Image a Model of an Object," filing date Aug. 28, 2000, which is hereby expressly incorporated by reference in its entirety. For example, the lead set region 914 of FIG. 9A is thresholded from image 940 in the iterative process by checking whether the region(s) segmented at a threshold value is rectangular. More particularly, pluralities of threshold values are tried, and the image 940 is binarized using each of the threshold values. The binary images are examined to determine whether one or more rectangular regions are present, where the shape is determined using tools known in the art, such as projection, for example. Different threshold values are tried until the binary image contains a substantially rectangular region or an even number of substantially rectangular regions.

An alternative way to segment the image is using U.S. Pat. No. 5,949,905 Nichani et al., assigned to Cognex Corporation, incorporated herein by reference.

A preferred embodiment, however, leverages the angle (800) to segment regions (802), and is described in co-pending U.S. application, Ser. No. 09/457,825, entitled, "Methods and Apparatuses for Identifying Regions of Similar Texture in an Image," filing date Dec. 9, 1999, which is hereby expressly incorporated by reference in its entirety (the "Texture Patent Application"). In this embodiment, the Texture Patent Application applies a one-dimensional Fourier analysis only at the angles that were obtained in the previous step (800), as opposed to searching all possible angles. The regions having frequencies with substantially the highest power are segmented out of the image, as is described further in the Texture Patent Application.

For example, the angle 45° or 135°, derived as previously described, of the leaded object 900 in the image 940 is used in accordance with the teachings of the Texture Patent Application to segment the lead set 914.

When the Texture Patent Application segments (802) the lead set 914 from the image 940, other regions, such as the logo 902, may also be segmented. Therefore, optionally, extraneous regions are identified and ignored by a post-processing step, such as filtering after segmentation (804) or filtering after some (814), or all (818), of the gauging (806) is complete.

Specifically, regions or features therein having an aspect in conflict with a validity norm are identified and ignored or removed. For instance, ignoring all non-rectangular regions will remove from evaluation the region containing the logo 902, where the shape is determined using tools known in the

art, such as a search tool using a synthetic model, for example. A further example ignores regions above an acceptable area threshold, given the magnification of the image **940**, where the area is determined using numerous tools known in the art, such as a connectivity tool or a caliper tool, for instance.

The aspects of the regions, and/or features within the regions used to filter the regions depend on the object being modeled, and, therefore, vary with the application.

As previously described, in a preferred embodiment, the angles of any spatial pattern found in the frequency space are input to the post processing step. In a preferred embodiment, the segmenting step indicates whether any of the angles derived as herein described were not the angles of the object and/or features (i.e., were incorrect angles). Specifically, no region is segmented using the incorrect angles or no region that passes the filters is segmented at the incorrect angles.

Next, the object and/or the features of the object are gauged (**806**), where gauging can be accomplished using various vision tools, and combinations thereof, tailored to the object and/or features, as should be apparent to those skilled in the art.

In the leaded object **900** example, each lead set region is gauged. FIG. **9B** depicts a portion of a region **922** of the lead set **914**. In one embodiment, the height **924** of the region **922** provides the lead length **910**, and the length **926** of the region **922** provides the length of the lead set **914** (**808**).

The dimensions of the leads **904** are measured more accurately as distances between edges of the leads **904**, where the edges are generated by applying an edge detector (**810**). From the edge data, the lead width **916**, the lead pitch **918**, (**812**) and, optionally, a refined value for the length of the lead set **914**, a refined value for the lead length **910**, and/or the foot length **920** (**816**) is determined. In one embodiment, edges corresponding to the sides of the leads **904**, such as edge **932** and edge **936**, for example, are found by accumulating edges along a projection axis, *p*, of a window **928**, where the window **928** is shaded in FIG. **9B** for illustration purposes.

The intensity of pixels within the window **928** along *p* are projected (i.e., added), thereby generating a one-dimensional image, which is illustrated graphically as histogram **930** of FIG. **9C**. Linear projection collapses an image by summing the grey values of the pixels in the direction of the projection. The summation tends to amplify edges in the same direction *asp*. After projection, the one-dimensional image is filtered to remove smaller transitions in grey value. The edge **932** is represented in the histogram **930** as a rising ramp **934**, and the edge **936** is represented in the histogram **930** as a falling ramp **938**. This functionality (i.e. identifying and filtering the edges) is typically provided in the industry as a single vision tool, usually known as a caliper tool. Each edge has a polarity (i.e., direction), where edge **932** has a dark-to-light polarity, also known as a positive polarity, and edge **936** has a light-to-dark polarity, also known as a negative polarity.

For the lead set **914**, FIG. **9D** depicts a partial edge list **944** containing the first seven edges of the histogram **930**. The edges are labeled from **0** through **6** according to the position of the edge from the left to right across the region **922**, such that edge **0** is positioned closest to the beginning of the window **928** and edge **6** edge is the farthest away of the edges within the partial edge list **944**. The edges are also labeled with the respective polarity by a plus or minus notation placed below the ordinal label.

The location of the regions and the angle of the features and/or object, derived as previously described, provide the

necessary information to properly place the window **928**. The width and height of the window **928** are determined using the area of the region **922**.

Alternatively, a connectivity analysis, a technique known in the art, segments the region **922**, and the width and the height of the window **928** is determined therefrom, and, in conjunction with the previously determined angle, the position of the window **928** is determined therefrom.

Once the edges are generated (**810**), the lead width **916** and the lead pitch **918** is determined (**812**) using a gauging technique, such as by finding the distance between parallel edges, which is a technique known in the art.

In one embodiment, the lead width **916** and the lead pitch **918** are found by pairing, based on polarity, the edges within the edge list **944**, so that the edge pairs represent the sides of each lead **904**, and then determining therefrom the lead width **912** and the lead pitch **914** (**812**).

The invention recognizes that pairing using the only known, (i.e., the polarity) will correlate enough of the edges with the proper lead side to determine a representative lead width and lead pitch.

The polarity constraint is dictated by the lighting of the object during imaging. For front lighting, the leads **904** image as bright features, and, therefore, an edge pair corresponding to the first lead **946** in the lead set **914** is a positive edge that is followed in the edge list **944** by a negative edge of a higher label number. A higher label number indicates the position of the second edge is to the right of the first edge in the edge pair, (i.e. the edges are paired going in the direction from left to right across the region **922** and the histogram **930**). Therefore, the edge pair of the first lead **946**, using the polarity constraint, is **0+** and **1-**. The edge pair corresponding to the second lead **948** is composed of edges with higher labels than the edge of the first lead **946**, and the edge pair includes a positive edge that is followed in the edge list **944** by a negative edge of a higher label number (i.e. **3+** and **4-**). The edge list **944** is traversed in this manner, from **0** to the last label (not shown) pairing all possible edges meeting the polarity constraints described above. Edges that are not paired, such as edge **2-**, are, optionally, discarded.

Then, the median width and the median pitch are determined from the positions of the edges in the edge pairs.

Preferably, the median width and the median pitch are refined using a second set of edge pairs that are generated by re-traversing the edge list **944**, which may include the discarded edges, such as edge **2-**, and re-pairing the edges using all the known values, where the known values now include: the polarity, the median width, and the median pitch. The constraints to pair edges now include both polarity and distance. An edge pair corresponding to the first lead **946** is a positive edge followed in the edge list **944** by a negative edge that is positioned at a distance, equal to, or greater than, the median lead width, plus or minus a tolerance, and has a higher label number, where the value of the tolerance will depend upon the application. In this example, edge **1-** is not within the tolerance of the median lead width distance from edge **0+**. Therefore, the edge pair of the first lead **946** is **0+** and **2-**. The first edge of the second lead **948** is again a positive edge, and it is positioned at a distance, equal to, or greater than, the median lead pitch, plus or minus the tolerance, from the edge **0+**. In this example, the first edge of the second lead **948** is edge **3+**. The second edge of the second lead **948** is again a negative edge, and it is positioned at a distance, equal to, or greater than, the median lead pitch, plus or minus the tolerance, from the edge **2-** (i.e., **4-**). Alternatively, the second edge of

the second lead **948** is again a negative edge, and it is positioned at a distance, equal to, or greater than, the median lead width, plus or minus the tolerance, from the edge **3+** (i.e., **4-**). The edge list **944** is traversed in this manner from **0** to the last label (not shown) pairing all possible edges meeting the polarity and distance constraints described above.

Thereafter, the median widths and pitches are recomputed using the refined set of edge pairs.

For back-lit images, the polarity constraints are reversed, where the term front lit and back-lit images are known in the art.

The technique described to associate the proper edge with a lead side can be used to associate edges with other boundaries without departing from the scope of the invention, such as associated edges with bar codes for instance. It should also be apparent that when the lighting is known (i.e., the polarity is known) the above technique can be used to differentiate between edges of a feature of interest and extraneous edges, whether the extraneous edges, for example, are due to noise or due to features not of interest, including differentiating edges from images of ball grid arrays, images of keys in key chains, and images of numerical key pads on phones or remote controls, for example.

Optionally, the lead set length is refined (**816**) as the distance between the first edge **932** of the first lead **946** and the second edge **952** of the last lead **954**.

Optionally, the foot length **920** is determined (**816**) from front-lit images, assuming that the foot is a single bright region, such as region **528** within FIG. **5B** described previously, for example. A window **942**, shaded for illustration purposes, is positioned, across one or more leads **904**, and generally orthogonal to window **928**. The grey values within the window **942** are projected along the projection axis, p_2 , to identify possible edges. The two edges that surrounding a bright region, that is a positive edge followed by a negative edge going in the up to down direction, and the two edges that are the furthest from the lead body are the edges of the foot **906**, which once identified provide the foot length **920**. Optionally, the edges of more than one foot for more than one lead **904** can be used to find the median foot length.

Further, when the window **942** crosses the ends of the leads **904**, optionally, the lead length **920** is also refined (**816**) from the edges found therein.

Next, the geometrical description is constructed (**820**). In addition to the gauged dimensions, the geometrical description often requires additional values that may be derived from the gauged dimensional information. In the lead set example, the geometrical description also includes the number of leads within the lead set, where the number of leads **904** within the lead set **914** equals the distance between the first lead **946** and the last lead **954** divided by the lead pitch **918** plus one. The distance between the first lead **946** and the last lead **954** is the length **926** of the region **922** or the position of the last edge **952** minus the position of the first edge **932**. Alternatively, the number of leads **904** equals the number of passing paired edges. The lead length **910**, the lead width **916**, the lead pitch **918**, the number of leads, and/or foot length **920** comprise part, or all, **8** of a typical geometric description (**820**) of the lead set **914**, which is used as a model. Additionally, the location **950** and angle **908** comprise, part or all, of the pose of the lead set **914** in the geometrical description. Further, the angle is, optionally, used to generate a complete description of a leaded object by properly combining at the angle of the lead set and the angle of the object the geometrical description of more than one lead set of a single leaded object.

The model is used in vision tasks as is, or refined further. Once the geometrical description is determined, optionally, features of the object are re-gauged to refine the dimensions. It should be apparent vision tools known in the art alone or in combination, can refine part, or all, of the geometrical description once it has been determined as herein described. The lead length and foot length are rougher than the other measurements, and are easily refined using calipers. In a preferred embodiment, the geometrical description is refined as described in co-pending patent application entitled "Methods and Apparatuses for Refining a Geometric Description of an Object Having a Plurality of Extensions", application Ser. No. 09/203,182, filed Nov. 30, 1998, assigned to Cognex Corporation.

It should be apparent that other more sophisticated tools, available in the art, can be used to further process and/or score edges, known in the art, according to the specificity required by the application.

It should also be apparent that the gauging description and construction of the geometrical description detailed above is an instance of gauging and modeling a gullwing lead set, and refinements thereto, or refinements to adapt the gauging and/or construction of the geometrical description to other objects and/or regions can be made without departing from the scope of the invention.

It should also be apparent that other objects can be modeled, such as a telephone display **1100**, or an averaged or representative crescent bond **1102** from among the group of crescent bonds **1104** depicted in FIG. **11**, not drawn to scale. Also, many of the objects for which the angle can be found, as described herein, can also be usefully modeled, including but not limited to pads, ball grid arrays, and calibration targets, for example.

Further, any image processing algorithm that uses synthetic models can use a model generated using the teachings herein once the segmenting, gauging, and/or constructing aspect of the modeling is tailored to the application.

Those skilled in the art will appreciate that some, or all, of the steps of generating a frequency response, finding angles, post-processing, segmenting, filtering, and gauging described hereinbefore can be combined and effected as hardware implementations, software implementations, or a combination thereof.

Furthermore, it should be appreciated that any of the images described herein can be subject to further processing, such as by filtering using a gaussian filter, median filter, smoothing filter, morphological filter or the like known in the art, in order to improve image quality.

Although connectivity tools and caliper tools are described herein for obtaining characteristics relating to the length, width, pitch, and area of the leads, lead sets, and/or feet of the leads for the model generation, it should be appreciated that the information relating to the characteristics of the features or object can be obtained using other vision tools known in the art or from a CAD tool or other machinery that requires or acquires and has information relating to the characteristics of interest. Alternatively, portions of the information can be manually obtained by an operator, entered into the system, and used in instead of, or as a starting value for, the characteristics.

It should be apparent that the output of the application of the frequency analysis can be stored, or represented as is, or by using formats other than a frequency image without departing from the scope of the invention, such as parametric representations to save space, for example.

It should also be apparent to those skilled in the art that the order of the model generation can be altered without departing from the scope of the invention.

Those skilled in the art will also realize that using reduced-resolution images upon which to apply the frequency analysis, evaluate the angle, find and/or evaluate the regions, or gauge, the image or regions, could decrease processing time. Further, any combination of full-resolution and reduced-resolution images can be used. However, use of reduced-resolution images typically results in a loss of accuracy.

Those skilled in the art will realize that processing time can also be decreased by performing any of the computations described herein using sampled data, such as finding angle from sampled data, for example, perhaps at the expense of performance. Sampled data is a subset of the available data points, such as every third data point, for instance.

Those skilled in the art will realize that the frequency analysis can be used to detect movement over time or changes in angle of features over process steps.

Those skilled in the art will realize that the image can be of an entire object, part of one object, or part of multiple objects.

Although the invention has been shown and described with respect to exemplary embodiments thereof, various other changes, omissions, and additions in the form of, and detail thereof, may be made therein without departing from the spirit and scope of the invention as claimed. Accordingly, the above description is not intended to limit the invention except as indicated in the following claims.

What is claimed is:

1. A method for generating a geometrical model of an object from an intensity image of the object, the method comprising:

generating at least a portion of a two-dimensional frequency response of the intensity image, the at least a portion of a two-dimensional frequency response being a frequency response to more than one frequency;

representing the at least a portion of a two-dimensional frequency response within a frequency space, the at least a portion of a frequency response providing features arranged in a spatial-frequency pattern within the frequency space;

finding an orientation of the spatial-frequency pattern to provide the orientation of the object;

gauging the object using the orientation so as to produce geometric-dimensional information; and

constructing the geometrical model of the object using the geometric-dimensional information.

2. The method of claim 1, further comprising:

using the geometrical model as an initial input into a more precise modeling procedure.

3. The method of claim 1, wherein the object has object features, the object features being within a region of the intensity image, and wherein gauging further includes:

gauging the object features within the region using the orientation so as to produce the geometric-dimensional information for the object features;

the method further comprising:

segmenting the region before gauging.

4. The method of claim 3, wherein segmenting the region further includes:

segmenting the region of the object using the orientation.

5. The method of claim 3, wherein segmenting the region further includes:

dividing at least a portion of the intensity image into sub-regions, each of the sub-regions having an origin;

generating a frequency characteristic along the orientation for each of the sub-regions; and

examining the frequency characteristic of each of the sub-regions to identify similar sub-regions, the similar sub-regions taken together providing the region.

6. The method of claim 3, wherein segmenting includes: segmenting a plurality of regions; the method further comprising:

ignoring at least one region of the plurality of regions having an aspect in conflict with a validity norm.

7. The method of claim 6, wherein the validity norm is a predetermined area threshold, and wherein ignoring further includes:

ignoring at least one region of the plurality of regions having an area above the predetermined area threshold.

8. The method of claim 1, wherein the object is a leaded object having lead set regions, and having leads within the lead set regions, and wherein the method further comprises: segmenting the lead set regions before gauging.

9. The method of claim 8, wherein segmenting the lead set regions further includes:

thresholding the intensity image at a plurality of multiple thresholds so as to produce a group of the lead set regions at each threshold of the plurality of multiple thresholds; and

segmenting the group of the lead set regions containing the lead set regions that are substantially rectangular.

10. The method of claim 8, further comprising:

ignoring at least one lead set region of the lead set regions having an aspect in conflict with a validity norm.

11. The method of claim 10, wherein the validity norm is a substantially rectangular shape, and wherein ignoring further includes:

ignoring at least one lead set region of the lead set regions with a shape unlike the substantially rectangular shape.

12. The method of claim 8, wherein gauging the object further includes:

applying an edge detection tool using the orientation so as to produce a lead width, and a lead pitch for each of the leads within at least one lead set region of the lead set regions.

13. The method of claim 8, wherein gauging the object further includes:

applying an edge detection tool using the orientation to produce a lead length and a foot length for the leads within at least one lead set region of the lead set regions.

14. The method of claim 1, wherein generating further includes:

generating the at least a portion of a two-dimensional frequency response of the intensity image by applying a frequency analysis tool to the intensity image.

15. The method of claim 14, wherein generating the at least a portion of a two-dimensional frequency response of the intensity image includes:

generating at least a portion of a magnitude of a two-dimensional discrete Fourier transform of the intensity image to provide the at least a portion of a two-dimensional frequency response.

16. The method of claim 14, wherein generating the at least a portion of a two-dimensional frequency response of the intensity image includes:

generating at least a portion of a two-dimensional discrete cosine-transform of the intensity image to provide the at least a portion of a two-dimensional frequency response.

19

17. The method of claim 1, wherein representing further includes:

representing the at least a portion of a two-dimensional frequency response as a logarithmically scaled frequency response within the frequency space.

18. The method of claim 1, wherein the frequency space is a frequency image, and wherein representing the at least a portion of a two-dimensional frequency response further includes:

scaling the at least a portion of a two-dimensional frequency response using a scaling function so as to enhance high frequency responses within the at least a portion of the two-dimensional frequency response to provide a scaled frequency response; and

mapping the scaled response by gray scale on the frequency image.

19. The method of claim 1, wherein finding further includes:

applying an angle finding means to the frequency space to provide an angle of the spatial-frequency pattern.

20. The method of claim 1, wherein finding further includes:

identifying the spatial-frequency pattern within the frequency space; and

finding the orientation of the spatial-frequency pattern.

21. The method of claim 1, wherein the features form a plurality of spatial-frequency patterns within the frequency space, and wherein finding further includes:

finding the orientation of the plurality of spatial-frequency patterns.

22. The method of claim 1, wherein the features form a plurality of spatial-frequency patterns within the frequency space, and wherein finding further includes:

identifying a dominant spatial-frequency pattern among the plurality of spatial-frequency patterns; and

finding the orientation of the dominant spatial-frequency pattern.

23. The method of claim 22, wherein identifying further includes:

identifying as the dominant spatial-frequency pattern, one spatial-frequency pattern of the plurality the spatial-frequency patterns that includes a greatest number of the features.

24. The method of claim 1, wherein the orientation of the object in the intensity image is at a constant offset from the orientation of the spatial-frequency pattern in the frequency space.

25. The method of claim 24, wherein the constant offset substantially equals zero.

26. The method of claim 24, wherein the orientation of the object substantially equals an orientation angle of a surface mount object from an axis of the intensity image.

27. The method of claim 1, wherein the spatial-frequency pattern includes a line, the line having, a line angle, and wherein the orientation of the object is an object angle, the object angle having a constant offset from the line angle.

28. The method of claim 27, wherein the orientation of the object is defined by an orientation angle of a feature on the object.

29. The method of claim 1, wherein finding the orientation of the spatial-frequency pattern further includes:

processing the frequency space as a second image to find the orientation of the spatial-frequency pattern therein.

30. The method of claim 1, wherein representing the at least a portion of a two-dimensional frequency response further includes:

interpreting the features of the at least a portion of a two-dimensional frequency response within the frequency space as image features in a second intensity image.

20

31. The method of claim 1, wherein finding the orientation of the spatial-frequency pattern further includes:

conducting a pattern analysis on the features.

32. The method of claim 1, wherein the features in the frequency space are formed from uv data and finding the orientation further includes:

interpreting the uv data as a second intensity image to find the orientation of the spatial-frequency pattern therein.

33. A method for generating a geometrical model of an object from an image of an object, the method comprising: acquiring the intensity image of the object;

generating at least a portion of a two-dimensional frequency response of the intensity image by applying a frequency analysis tool to the intensity image, the at least a portion of a two-dimensional frequency response being a frequency response to more than one frequency, frequencies within the at least a portion of a frequency response forming a spatial-frequency pattern;

finding an orientation of the spatial-frequency pattern to provide the orientation of the object;

gauging the object using the orientation so as to produce geometric-dimensional information; and

constructing the geometrical model of the object using the geometric-dimensional information.

34. The method of claim 33, wherein generating further includes:

representing the at least portion of a two-dimensional frequency response within a frequency space, features within the frequency space forming the spatial-frequency pattern.

35. The method of claim 34, wherein the frequency space is a frequency image, and wherein representing the at least a portion of a two-dimensional frequency response further includes:

scaling the at least a portion of a two-dimensional frequency response using, a scaling function so as to enhance high frequency responses within the at least a portion of the two-dimensional frequency response to provide a scaled frequency response; and

mapping the scaled response by gray scale on the frequency image.

36. The method of claim 33, wherein generating the at least a portion of a two-dimensional frequency response of the intensity image includes:

generating at least a portion of a magnitude of a two-dimensional discrete Fourier transform of the intensity image to provide the at least a portion of a two-dimensional frequency response.

37. The method of claim 33, wherein the orientation of the object in the intensity image is at a constant offset from the orientation of the spatial-frequency pattern in the frequency space.

38. The method of claim 33, wherein the spatial-frequency pattern includes a line, the line having a line angle, and wherein the orientation of the object is an object angle, the object angle having a constant offset from the line angle.

39. The method of claim 38, wherein the orientation of the object is defined by an orientation angle of a feature on the object.

40. The method of claim 33, wherein the object has object features, the object features being within a region of the intensity image, and wherein gauging further includes:

gauging object features within the region using the orientation so as to produce the geometric-dimensional information for the object features;

the method further comprising:

segmenting the region before gauging.

21

41. The method of claim 40, wherein segmenting further includes:

dividing at least a portion of the intensity image into sub-regions, each of the sub-regions having an origin; generating a frequency characteristic along the orientation for each of the sub-regions; and

examining the frequency characteristic of each of the sub-regions to identify similar sub-regions, the similar sub-regions taken together providing the region.

42. The method of claim 33, wherein generating the at least a portion of a two-dimensional frequency response further includes:

representing the spatial-frequency pattern in a frequency space; and

wherein finding the orientation further includes:

processing the frequency space as a second intensity image to find the orientation of the spatial-frequency pattern therein.

43. An apparatus for generating a geometrical model of an object from an image of the object, the apparatus comprising:

frequency means adapted to generate at least a portion of a two-dimensional frequency response of the intensity image, the at least a portion of a two-dimensional frequency response being a frequency response to more than one frequency;

a frequency space adapted to receive the at least a portion of a two-dimensional frequency response, the at least a portion of a frequency response providing features arranged in a spatial-frequency pattern within the frequency space;

finding means, adapted to find an orientation of the spatial-frequency pattern to provide the orientation of the object;

gauging means, in cooperation with the finding means, adapted to gauge the object using the orientation so as to produce geometric-dimensional information; and

modeling means, in cooperation with the gauging means, adapted to construct the geometrical model of the object using the geometric-dimensional information.

44. The apparatus of claim 43, wherein the frequency means is further adapted to generate the at least a portion of a two-dimensional frequency response of the intensity image by applying a frequency analysis tool to the intensity image.

45. The apparatus of claim 44, wherein the frequency means is further adapted to generate at least a portion of a magnitude of a two-dimensional discrete Fourier transform of the intensity image to provide the at least a portion of a two-dimensional frequency response.

46. The apparatus of claim 43, wherein the frequency space is a frequency image, the apparatus further comprising:

scaling means, adapted to scale the at least a portion of a two-dimensional frequency response on the frequency

22

space using a scaling function so as to enhance high frequency responses within the at least a portion of the two-dimensional frequency response and to provide a scaled frequency response; and

mapping means, in cooperation with the scaling means, adapted to map the scaled frequency response by grey scale on the frequency image.

47. The apparatus of claim 43, wherein the orientation of the object in the intensity image is at a constant offset from the orientation of the spatial-frequency pattern in the frequency space.

48. The apparatus of claim 47, wherein the orientation of the object is defined by an orientation angle of a feature on the object.

49. The apparatus of claim 43, wherein the spatial-frequency pattern includes a line, the line having a line angle, and wherein the orientation of the object is an object angle, the object angle having a constant offset from the line angle.

50. The apparatus of claim 43, wherein the object has object features, the object features being within a region of the intensity image, and wherein the gauging means is further adapted to gauge the object features within the region using the orientation so as to produce the geometric-dimensional information for the object features;

the apparatus further comprising:

segmenting means, in cooperation the gauging means, adapted to segment the region before gauging.

51. The apparatus of claim 50, wherein the segmenting means further includes:

dividing means adapted to divide at least a portion of the intensity image into sub-regions, each of the sub-regions having an origin;

sub-region frequency means, in cooperation with the dividing means, adapted to generate a frequency characteristic along the orientation for each of the sub-regions; and

examining means, in cooperation with the sub-region frequency means, adapted to examine the frequency characteristic of each of the sub-regions to identify similar sub-regions, the similar sub-regions taken together providing the region.

52. The apparatus of claim 43, wherein the finding means is further adapted to processes the frequency space as a second intensity image to find the orientation of the spatial-frequency pattern.

53. The apparatus of claim 43, wherein the features within the frequency space are image features of a second intensity image.

54. The apparatus of claim 43, wherein the finding means is further adapted to conduct a pattern analysis on the frequency space.

* * * * *